



1

ENCLOSURES

CATALOGUE EDITION 5

Enlec®
Polycarbonate Enclosures for Electronic & Electrical Applications



Pg.32

Utilec®
Standard General Purpose GRP Enclosures



Pg. 38

RL
Basic Hinged Enclosures



Pg. 42

Okari®
Modular Wall Mounted GRP Enclosures

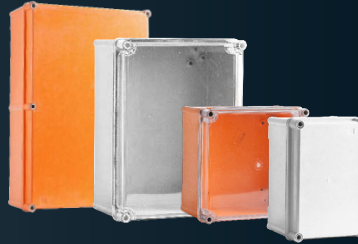

Pg. 44

UB-40
UB-41
Round GRP
Junction Boxes



Pg. 48

Allbrox®
Worlds leading range of industrial enclosures

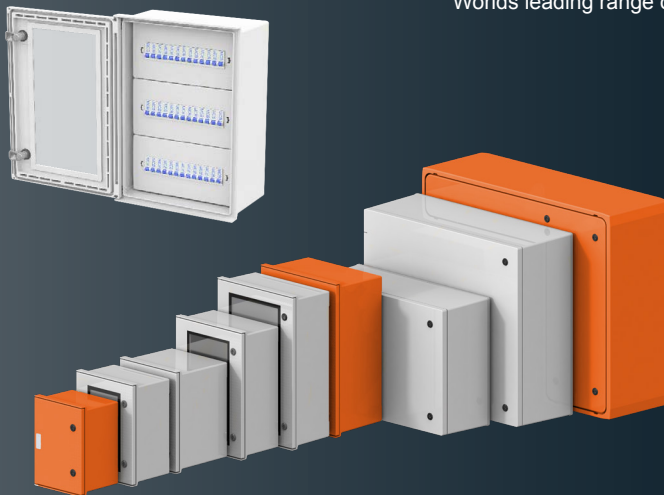

Pg. 56

PV Combiner Brick



Pg. 64

Terminal Range
High Impact GRP Enclosures for Tough Environments

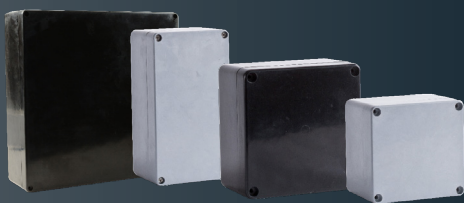

Pg. 46

AllTilt®
Pole Top Enclosures for Distribution and Metering



Pg. 90

Ready Boards



Pg. 68

Camera-Den™

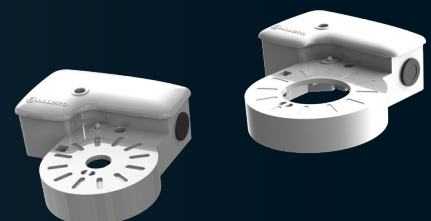

Pg. 36

Weatherproof Socket Outlet Boxes



Pg. 75

Modular Manhole Systems



Pg. 23

Pool Boxes

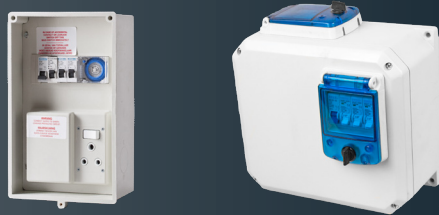

Pg. 80

ADB Distribution Boards



Pg. 83

Empty & Pre-configured boxes for metering & distribution



Pg. 88

AllRobust™



Pg. 52

AllVault™ High Security Enclosure



Pg. 93

Fablec

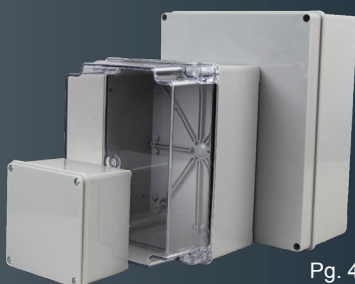

Pg. 41

Slab Box™



Pg. 66

Data Cable Accessories

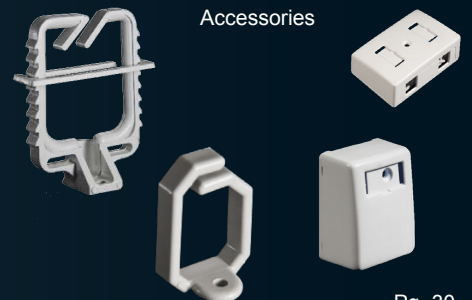

Pg. 30

One of our core competencies is the design and manufacture of non-metallic electric enclosures. Various insulation materials are used in our production process:

The two main families of materials can be separated into:

- Plastics - Injection Moulded
- Glass Reinforced Polyester (GRP) - Compression Moulded

Plastics

18 Injection moulding machines up to 400T.



GRP - Compression moulding 120 machines up to 800T.





* Assembly

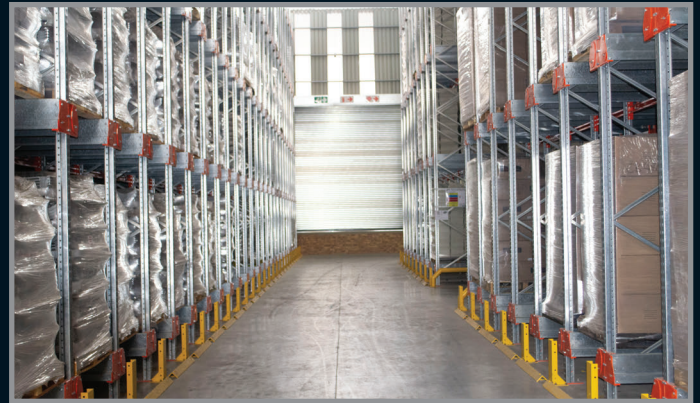

* Bulk Storage warehouse

Enclosures

Hinges

Locks

Handles

Accessories

Rotary Operating Handles

Insulators

Transformer Equipment

Index

Glass Reinforced Polyester (GRP)

Modern industries demand structural materials that are lightweight, strong and versatile. Materials that resist corrosion and temperature extremes and which deliver freedom of design and low system costs. The ideal solution is a family of structural, fibre reinforced thermosets: SMC (Sheet Moulding Compound) and DMC (Dough Moulding Compound). These materials combine mechanical and physical properties with the lowest system cost, without compromising quality.

Exceptional electrical and UV properties make GRP the material of choice for outdoor electrical enclosures.

Allbro compounds its own SMC and DMC. Numerous formulations have been engineered to address different technical application challenges. Since DMC and SMC are composite materials, we are able to dramatically change aspects like strength, conductivity, surface finish, colour, chemical compatibility etc..

Dough Moulding Compound (DMC) (Also known as BMC)



Sheet Moulding Compound (SMC)



DMC compared to SMC

DMC



Fibre lengths 6, 12, 18 mm

SMC



Fibre lengths 25-50mm

* See Material Properties on Page 14 for detailed information

Enclosures

IEC 60695-11-10 Needle Flame Test or UL94 - Flame Resistance Test

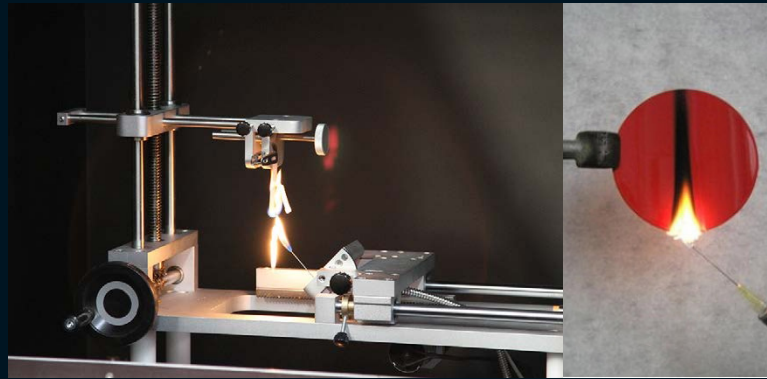

Hinges

Locks

Handles

Accessories

5VA Surface Burn	Burning stops within 60 seconds after five applications of five seconds each of a flame (larger than that used in Vertical burn testing) to a test bar. Test specimens MAY NOT have a burn-through (no hole). This is the highest (most flame retardant) UL94 rating.
5VB Surface Burn	Burning stops within 60 seconds after five applications of five seconds each of a flame (larger than that used in Vertical burn testing) to a test bar. Test specimens MAY HAVE a burn-through (a hole).
V-0 Vertical Burn	Burning stops within 10 seconds after two applications of ten seconds each of a flame to a test bar. NO flaming drips are allowed.
V-1 Vertical Burn	Burning stops within 60 seconds after two applications of ten seconds each of a flame to a test bar. NO flaming drips are allowed.
V-2 Vertical Burn	Burning stops within 60 seconds after two applications of ten seconds each of a flame to a test bar. Flaming drips ARE allowed.
H-B Horizontal Burn	Slow horizontal burning on a 3mm thick specimen with a burning rate of less than 3"/min or stops burning before the 5" mark. H-B rated materials are considered "self-extinguishing." This is the lowest (least flame retardant) UL94 rating.

Rotary Operating
Handles

Insulators

Transformer
Equipment

Index

IEC 60695-2-11 Glow Wire Test

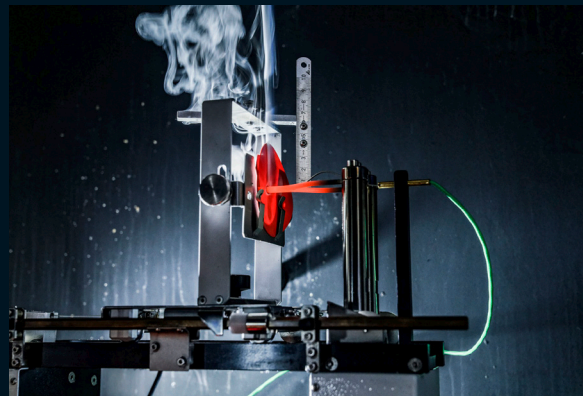

Glow wire tests are a requirement for enclosures that house electrical circuits. It is a very important requirement for materials that are made from petrochemical base materials. Plastics and Resin materials both fall into this category.

The importance of verifying the properties of the insulation material has been illustrated recently with the Grenfell Tower fire in 2017. Glow wire testing for electrical enclosures is traditionally done at 3 different temperatures depending on where the part is used in the system. A cover can be tested at 650° whilst boxes that are built into a wall need to be tested at 850° and a part that is in contact with current carrying components should be tested at 960°. Due to the confusion that can be created many end-users ask for an additional test to be performed which is a needle flame test. The reason for this is that 650° is often not a high enough temperature to ignite the material so the flammability is not necessarily tested.



It is recommended that all enclosures that are installed in public spaces are glow-wire tested to 960° (IEC 60695-2-11) as well as Needle flame (IEC 60695-11-10)

Extended - Real Life Flammability Test

While Needle flame is an interesting flammability test for plastics in general the test below shows how much better SMC performs against even the most advanced engineered V0 plastics. Such testing is being introduced in places where "Veld Fires" (Bush fires) are a possibility. The test below is not a standard IEC test. In this test an enclosure is exposed to a 4-min burn instead of a 30 second small flame exposure.

The challenge that even self-extinguishing plastics experience is that they can only self extinguish once the flame source is removed. A sustained arc or external flame renders even fire-retardant plastics to essentially become a fuel source for the flame. When such an enclosure is mounted to a wooden pole or a building the concentrated source of fuel can create devastation. SMC is therefore a better choice than plastic.

Thermoplastic Cabinet UL94 V0

SMC Cabinet

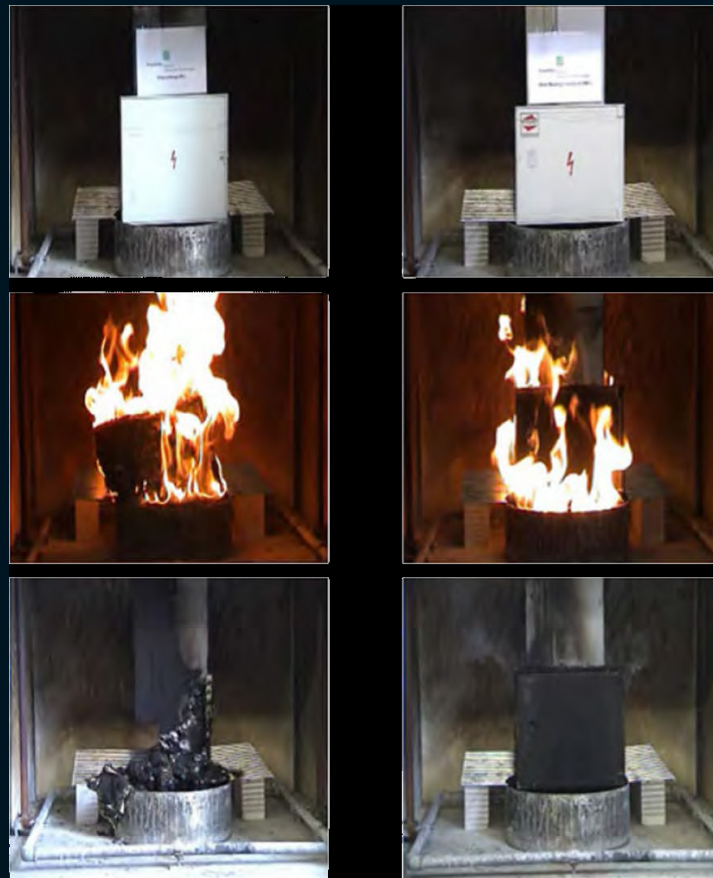

Retention of dimensional properties: GRP compared with plastics

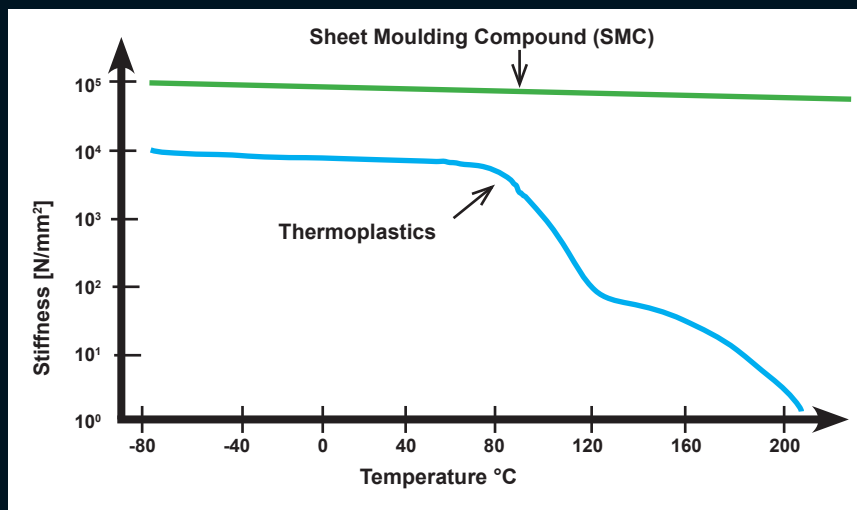

Enclosures

Hinges

Locks

Handles

Accessories

Rotary Operating Handles

Insulators

Transformer Equipment

Index

Enclosures

“GRP is Green”

Energy use is an important element in the total environmental impact of a product. Producing materials from base materials requires energy in each step of the process. A way to compare the energy use for the production of a part is to calculate back to equal properties. In the graph below the relative use for producing a part with equal tensile strength and equal tensile stiffness is represented:

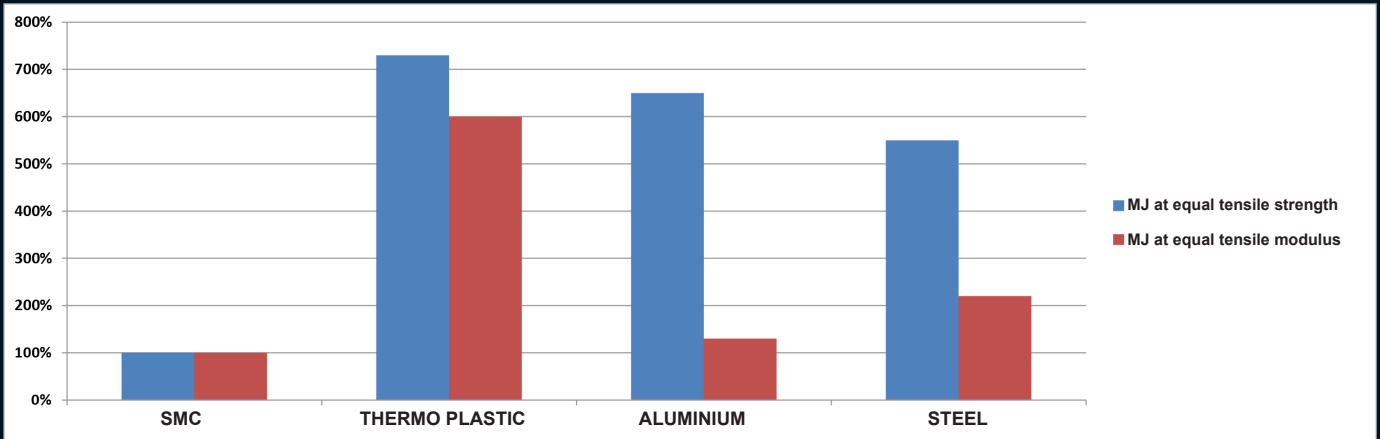

Hinges

Locks

Handles

Accessories

“ a part produced in SMC requires 5-7 times less energy to be produced than producing the same part in steel, aluminium or thermoplastic materials at equal strength”

Rotary Operating Handles

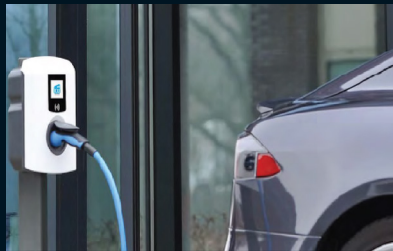

Insulators



Transformer Equipment

Index



* SMC manufacturing line



* DMC manufacturing line



* DMC mixing Z blades

SMC and DMC manufacturing process

SMC is made as a continuous sheet. The resin paste is transferred to a doctor box where it is deposited onto a moving carrier film passing directly beneath. The doctor box controls the amount of the resin paste applied. Simultaneously, glass fibre rovings are fed into a rotary cutter above the resin-covered carrier film. Fibres are chopped to length (generally 25mm or 50mm) and randomly deposited onto the resin paste. The amount of glass is controlled by the cutter and by the speed of the carrier film. Downstream from the chopping operation, a second carrier film is coated with resin paste and is laid, resin side down, on top of the chopped fibres. This stage of the process creates a resin paste and glass fibre 'sandwich' which is then sent through a series of compaction rollers where the glass fibres are consolidated with the resin paste and air is squeezed out of the sheet.

Sheet dimensions are normally 2-4 mm thick and 1.1 mm wide. The length and weight of the SMC sheet is determined by moulder preference for handling and is usually stored on a 350kg (standard) up to 1500kg rolls or bi-folded (like computer paper) into large bins. Modern SMC production is a highly automated and computer regulated process. Before the SMC can be used for moulding it must mature. This maturation time is necessary to allow the relatively low-viscosity resin to chemically thicken. The SMC will be kept in a maturation room at a controlled temperature (normally 48 hours at 30°C) and typically requires two to five days to reach the desired moulding viscosity. Usually SMC has a shelf life ranging from several weeks to several months from the date of manufacture. The time frame can be extended or reduced depending on the SMC formulation and storage conditions.

Like SMC, DMC is a fibre reinforced composite material which primarily consists of an amalgam of thermosetting resin, chopped glass fibre reinforcement and filler in the form of a bulk material. Additional ingredients such as low profile additives, cure initiators, thickeners and mould release agent are added to enhance processing performance. DMC is less loaded with glass fibres than SMC and fibre length is shorter at 6 to 12mm. Filler loadings are higher than for SMC. There are several techniques for the batch production of DMC. The most common mixing process involves a Z-blade mixers which amalgamates the resin paste, fillers, additives and reinforcements into a mass material with a dough-like consistency. The bulk product is packed in plastic bags impermeable to styrene diffusion and supplied in bins. Like with SMC, it can be supplied in pre-weighed charges according to customer needs.

Enclosures

Hinges

Locks

Handles

Accessories

Rotary Operating
Handles

Insulators

Transformer
Equipment

Index

	Typical property	standard	units	SMC 1-20	SMC 2-20	BMC/DMC
Enclosures	Density	ISO 1183	g/ccm	1.8	1.8	1.8
	Fibre content	EN ISO 1172	mass-%	20	30	18
Hinges	Fibre type			Glass	Glass	Glass
	Recycling code	VDA 260		UP-GS20	UP-GS30	UP-GS20
	Recyclable	-	-	Yes	Yes	Yes
	Young´s modulus 1)	EN ISO 527-4	GPa	9	10.5	13
Locks	Tensile strength 1)	EN ISO 527-4	MPa	55	70	31
	Tensile rupture strain 1)	EN ISO 527-4	%	1.4	1.4	0.4
	Compression strength 1)	EN ISO 14126	MPa	160	160	160
	Poisson´s ratio 1)	EN ISO 527-4	-	0.3	0.3	0.3
Handles	Flex modulus 1)	EN ISO 14125	GPa	10.5	10.5	9.5
	Flexural strength 1)	EN ISO 14125	MPa	150	165	90
	Impact strength 1)	EN ISO 179	KJ/m ²	60	70	30
	CTE 1)	ISO 11359-2	10-6m/mK	18	18	18
Accessories	Continuous service temperature	Similar to IEC 216	°C	150	150	150
	Short term service temperature	-	°C	210	210	210
	Heat distortion temperature	EN ISO 75-2	°C	200	200	200
	Specific heat capacity	-	J/gK	1.1	1.1	1.1
Rotary Operating Handles	Volume resistivity	IEC 60093	Ohm*cm	10 ¹²	10 ¹²	10 ⁷
	Surface resistivity	IEC 60093	Ohm	10 ¹⁴	10 ¹⁴	10 ⁹
	Comparative tracking index	IEC 60112	CTI	600	600	600
	Dielectric strength	IEC 60243-1	kV/mm	25	25	25
Insulators	Dielectric constant	IEC 60250	-	4.5	4.5	4.5
	Dissipation factor	IEC 60250	-	0.01	0.01	0.01
	Oxygen index	EN ISO 4589-2	%	22	22	22
	Flammability	UL 94	level/thickness	V0/3.2mm	V0/3.2mm	V0/3.2mm
Transformers Equipment	Flammability	ISO 3795	Class/thickness	NBR/3.2mm	NBR/3.2mm	NBR/3.2mm
	Fire / smoke	EN 45545	Hazard Level			
	Glow bar	IEC 60707	level	BH2-95	BH2-95	BH2-95
	Glow wire	IEC 60965-2-1	°C	960	960	960
Index	Water absorption	ISO 62	% after 24h	<0.3	<0.3	<0.3

Notes:

All materials supplied for SMC/BMC are in accordance with: ROHS, SMC/BMC materials do not contain heavy metals, asbestos, halogens or other toxic materials. All values in this table are representative mean values taken from compression moulded flat panels. Properties may vary due to modifications of products, moulding conditions or environmental influence. Properties given are accurate to the best of our current know-how and experience.

All reinforcement glass fibres used are textile glass fibres of a diameter greater than 14 microns and cannot be inhaled or otherwise ingested.

Textile fibres are not hazardous fibres.

SMC and BMC are recyclable materials.

RATING KEY:

E	Excellent	P	Poor
G	Good	NR	Not Recommended

Chemical	Rating	Chemical	Rating	Chemical	Rating
Acetic Acid (10%)	E	Fluorine	NR	Perchloroethylene	E
Acetone	P	Formaldehyde	E	Petrol	G
Acetaldehyde	NR	Formic Acid	E	Phosphoric Acid (25%)	P
Aluminium Chloride (10%)	E	Glycerine	E	Phosphoric Acid (50%)	NR
Aluminium Sulfate (10%)	E	Hydraulic Brake Fluid	E	Potassium Carbonate	E
Ammonia Gas	E	Hydraulic Oil	E	Potassium Chloride (25%)	E
Ammonium Chloride	E	Hydrochloric Acid (10%)	G	Potassium Hydroxide (25%)	NR
Ammonium Hydroxide (10%)	P	Hydrocyanic Acid	NR	Potassium Nitrate (10%)	E
Ammonium Nitrate (10%)	E	Hydrofluoric Acid (20%)	NR	Potassium Sulfate (10%)	E
Ammonium Phosphate(10%)	G	Hydrogen Peroxide	G	Sodium Bicarbonate (10%)	E
Ammonium Sulfate	E	Hydrogen Sulphide	E	Sodium Bisulfate (10%)	P
Aniline	NR	Hypochlorous Acid	E	Sodium Chloride (25%)	E
Axle Grease	E	Isopropyl Alcohol	E	Sodium Hydroxide	NR
Benzene	E	Kerosene	E	Sodium Hypochlorite (15%)	G
Boric Acid (10%)	E	Lacquer Thinner	E	Sodium Nitrate (10%)	E
Bromine	P	Lactic Acid	E	Sodium Phosphate (10%)	E
Butyl Acetate	P	Lime	G	Sulphuric Acid (25%)	E
Butyric Acid	E	Liquid Dish Soap (10%)	E	Sulphurous Acid (10%)	NR
Calcium Chloride (10%)	E	Lubricating Oils	E	Tannic Acid (10%)	E
Calcium Hydroxide (10%)	E	Magnesium Chloride (10%)	E	Tetrahydrofuran	P
Calcium Hypochlorite (10%)	G	Magnesium Hydroxide (10%)	E	Toluene	E
Calcium Sulfate	E	Mercuric Chloride	G	Trichloroethylene	NR
Carbolic Acid (25%)	P	Isopropyl Alcohol	E	Trisodium Phosphate	G
Carbon Disulfide	P	Kerosene	E	Turpentine	G
Carbon Tetrachloride	G	Lacquer Thinner	E	Vegetable Oils	E
Chlorine (dry)	E	Lactic Acid	E	Vinegar	E
Chlorine (water) 5-10 ppm	P	Lime	G	Water, Industrial	E
Chlorobenzene	E	Liquid Dish Soap (10%)	E	Water, Sea	E
Chloroform	NR	Lubricating Oils	E	Water, Tap	E
Chrome Plating Solutions	P	Magnesium Chloride (10%)	E	Xylene	E
Chromic Acid (10%)	E	Magnesium Hydroxide (10%)	E	Zinc Acetate	E
Citric Acid (10%)	G	Mercuric Chloride	G	Zinc Chloride	E
Copper Sulfate (30%)	E	Methyl Ethyl Ketone	P	Zinc Sulfate	E
Creosote	P	Methylene Chloride	E		
Diethyl Ether	E	Milk	E		
Ethyl Alcohol	E	Mineral Oil	E		
Ethylene Dichloride	P	Mineral Spirits	E		
Ethylene Glycol	E	Nickel Salts	E		
Ferric Chloride	E	Nitric Acid (10%)	G		
Ferric Nitrate	E	Nitrobenzene	P		
Ferric Sulfate	E	Oleic Acid	E		

*Note: This table is for reference purposes only. Allbro suggests real life testing within applications to ensure compatibility.

Enclosures

Hinges

Locks

Handles

Accessories

Rotary Operating Handles

Insulators

Transformer Equipment

Index

Allbro has become a leading innovator in the markets we serve. 4% of sales revenue is spent on R&D currently. Which is 8 times more than the company spends on marketing. Several "world first" concepts have been created in the past few years. In house design & tool making capabilities allow the company to rapidly take an idea and turn it into a final product.

Concept:

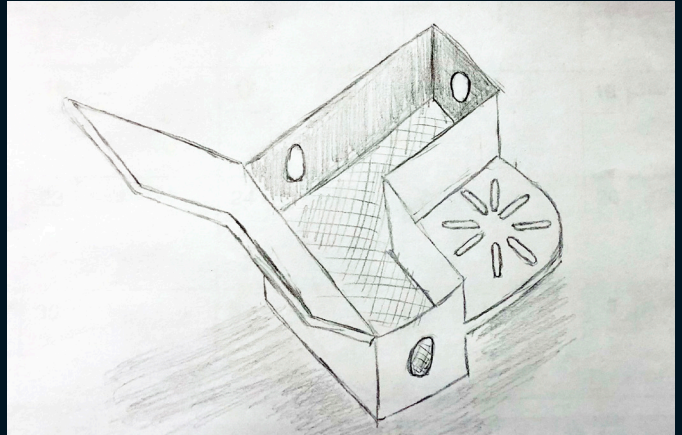
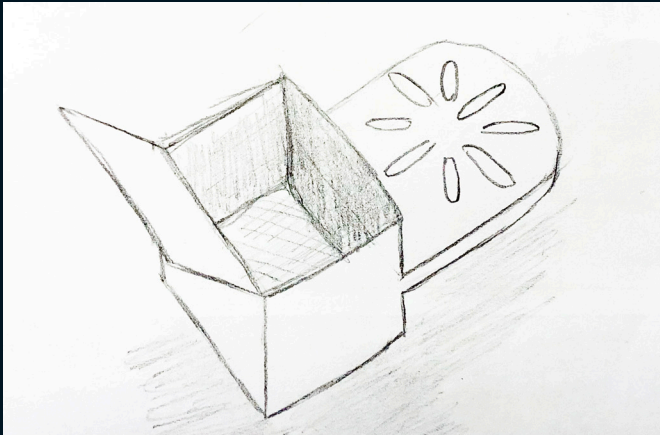

Design:

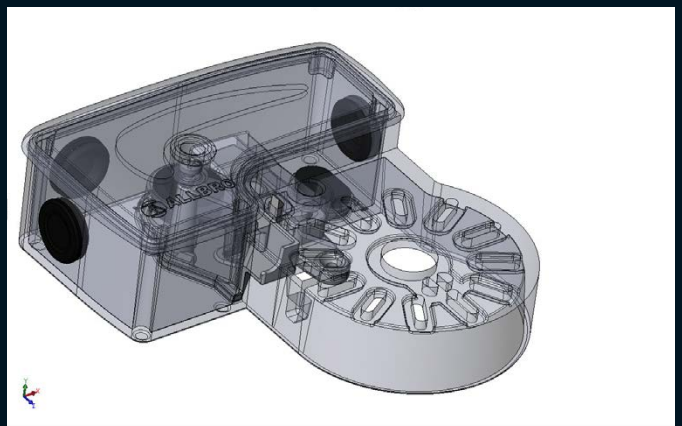
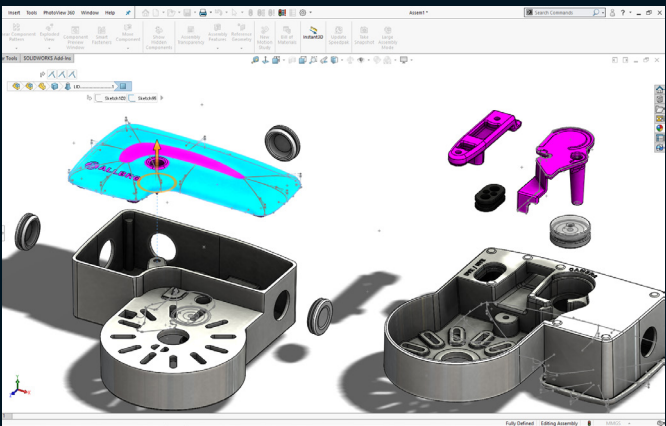

Tool Manufacturing:



Notes:

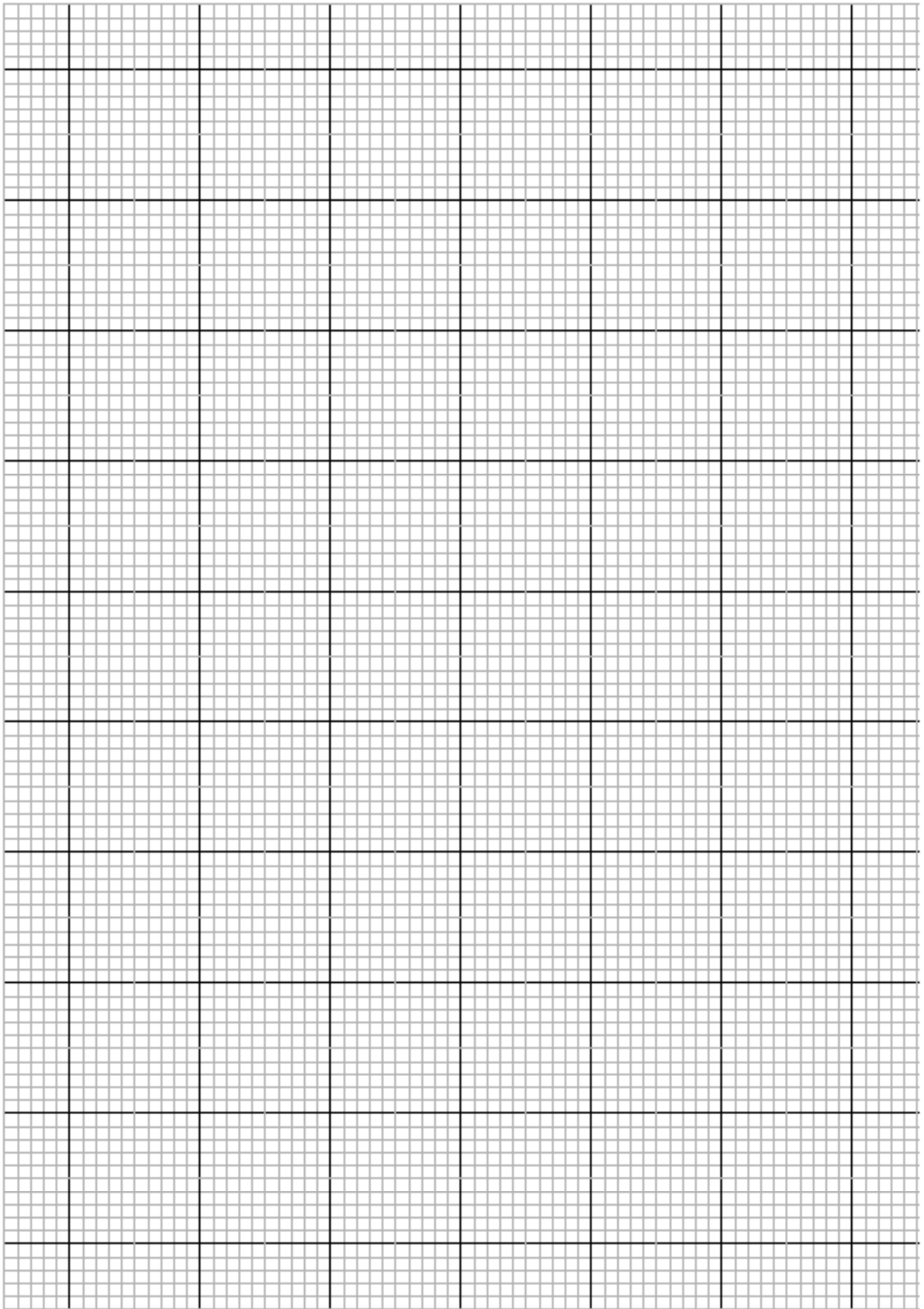

Enclosures

Damage to enclosures may impair the proper function of the installed equipment — e.g. Switch control gear — or, in the worst case, even render it inoperative, As well as affect the Ingress Protection (protection against dust and water) of the enclosures. The relevant protection category that specifies an enclosures resistance to impacts is the IK code - IEC62262. This IK code classification is established using a standardised testing method in line with the standard.

Hinges

Degree of protection against external mechanical impacts (IK code)

Verification of the degree of protection against mechanical impacts shall be carried out in accordance with IEC 62262 by means of a test hammer suitable for the dimensions of the enclosure.

The enclosure shall be fixed on a rigid support as for normal use.

Locks

The impact energy shall be applied:

- Three times to each exposed surface in normal use whose largest dimension is not above 1m
- Five times to each exposed surface in normal use whose largest dimension is greater than 1m.

The test shall not be applied to the enclosure components(locks, hinges, etc.)

The impacts shall be applied with even distribution over the faces of the enclosure.

Handles

After the test, the enclosure shall continue to provide the Ingress Protection code and dielectric strength.

IK code and impact energy

IK code	IK00	IK01	IK02	IK03	IK04	IK05	IK06	IK07	IK08	IK09	IK10
Impact energy (joule)	*	0,14	0,2	0,35	0,5	0,7	1	2	5	10	20

Accessories

Impact test characteristics

IK code	IK00	IK01 to IK05	IK06	IK07	IK08	IK09	IK010
Impact energy (joule)	*	<1	1	2	5	10	20
R mm (radius of striking element)	*	10	10	25	25	50	50
Mass kg	*	0.2	0.5	.5	1.7	5	5
Pendulum hammer	*	Yes	Yes	Yes	Yes	Yes	Yes
Free fall Weight	*	No	Yes	Yes	Yes	Yes	Yes
Free fall Height	*	No	20cm	40cm	29,5cm	20cm	40cm

Insulators



Transformer Equipment

IK Testing
*Photo taken in Allbro's Testing Lab

Index

- Static loads: Test 1.25 x maximum permissible load as declared by manufacturer for 1 hour.
- Lifting: Applicable to enclosures with lifting accessories.
- Axial loads of metal inserts: When threaded metal inserts are provided to retain the mounting plate/switch control gear supported.
- IK code: Test according to standard IEC 62262 with pendulum impact tester. After testing, the enclosure keeps its IP rating.
- IP rating: Test according to standard IEC 60529. Degree of protection against access to hazardous parts and the penetration of solid bodies and against the penetration of water.
- Thermal stability at a temperature of 70°C for duration of 168 hours.
- Resistance to abnormal heat and to fire: Glow wire test according to IEC 60695-2-10 and IEC 60695-2-11 (1).
- Dielectric strength: 5000V (1)
- Protection circuit continuity (2): Resistance not to exceed 0.1 ohm
- Weather resistance: Duration 500h (cycle: rain 5 minutes + UV lamp 25 minutes)
- The degree of protection provided by the enclosures are defined by standards IEC 60529 (IP) and IEC 62262 (IK)
- Degrees of protection are indicated by the letters IP followed by two characteristic numerals. The numerals show the degree of protection offered by the enclosure against access to dangerous parts, the penetration of solid bodies (1st numeral) and against the penetration of liquids (2nd numeral).
- The protection against external mechanical impact is indicated by the letters IK followed by a characteristic group numeral.

IP Rating for Enclosures IEC 60529

Since enclosures require periodic maintenance conducted by specialists, additional regulations establish the requirements that the manufacturer of these products should have to ensure technical operations are carried out safely. IEC 60529 is an international standard that was created for the purpose of clarifying the capability of an enclosure to protect the contents from solid and liquid bodies.

Allbro is one of a handful of manufacturers in the world that test several production and not just for initial design verification / certification .

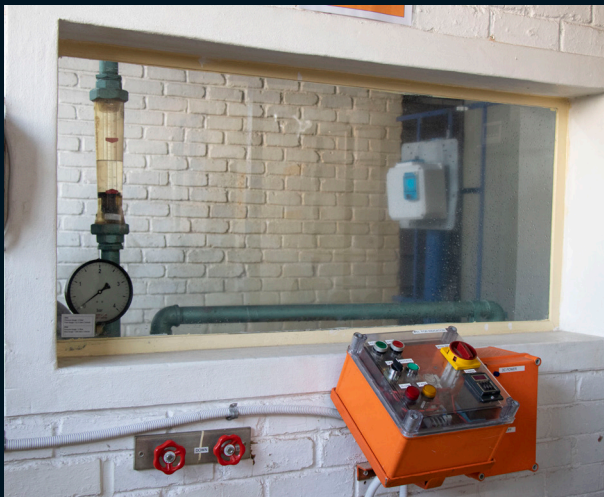

IP Level Testing

*Photos taken in Allbro's Testing Lab

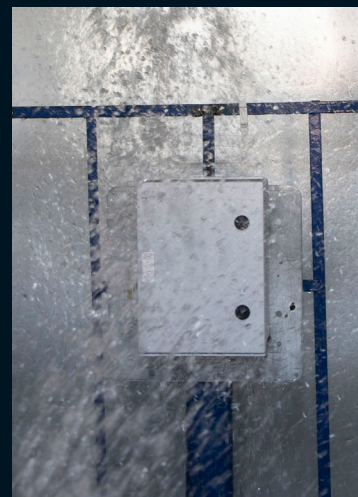

Enclosures

Hinges

Locks

Handles

Accessories

Rotary Operating
Handles

Insulators

Transformer
Equipment

Index

Enclosures
Hinges
Locks
Handles
Accessories
Rotary Operating Handles
Insulators
Transformer Equipment
Index

IP

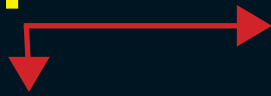

Protection against liquids

IK

Protection against force

Protection against solid bodies

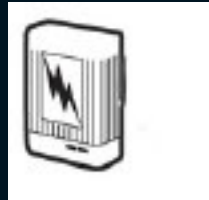

0
No Protection

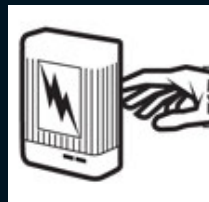

1
Protected against solid bodies larger than 50 mm (e.g. a hand)

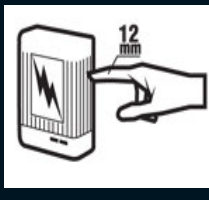

2
Protected against solid bodies larger than 12 mm (e.g. a finger)

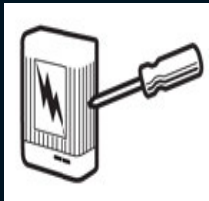

3
Protected against solid bodies larger than 2.5 mm (tools, wires)

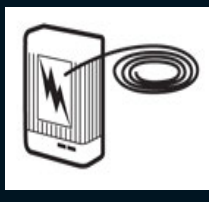

4
Protected against solid bodies larger than 1 mm (fine tools, small wires)

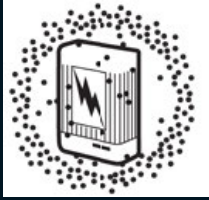

5
Protected against dust (no harmful deposits)

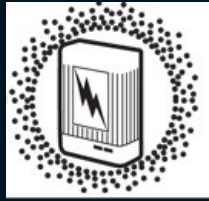

6
Totally dust tight

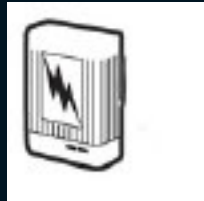

0
No Protection

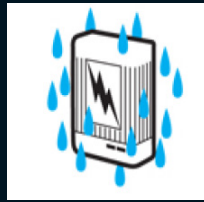

1
Protected against vertically falling water droplets (condensation)

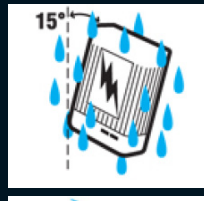

2
Protected against water droplets deflected at up to 15° from vertical

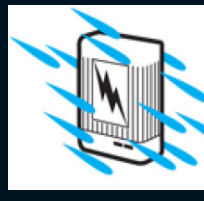

3
Protected against rainwater at up to 60° from vertical

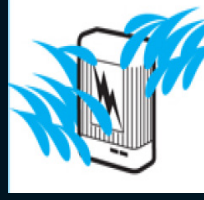

4
Protection against water spray from all directions

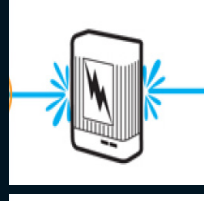

5
Protected against low - pressure water jets from all directions



6
Protected against powerful water jets from all directions

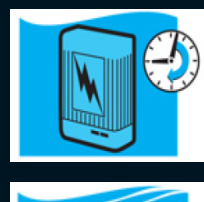

7
Protected against the effects of immersion

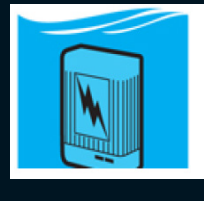

8
Protected against prolonged effects of immersion under pressure



0
No Protection

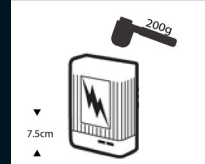

01
Impact energy 0.150 Joules

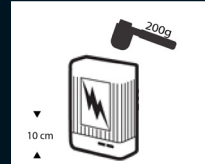

02
Impact energy 0.200 Joules

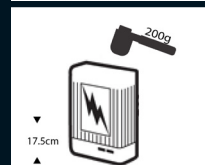

03
Impact energy 0.350 Joules

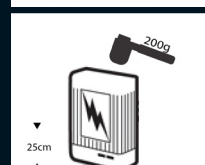

04
Impact energy 0.500 Joules

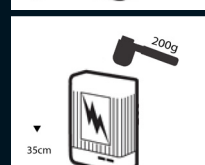

05
Impact energy 0.700 Joules

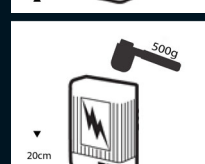

06
Impact energy 1.00 Joules

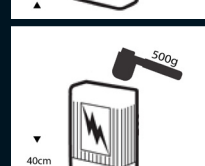

07
Impact energy 2.00 Joules

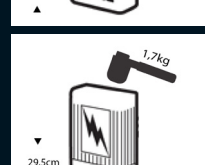

08
Impact energy 5.00 Joules

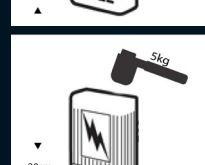

09
Impact energy 10.00 Joules

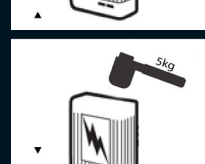

10
Impact energy 20.00 Joules

No standard exists for enclosure access, so to make things easier we have created one of our own.

Security Level

1	2	3	4
----------	----------	----------	----------

Open Access - Enclosure can be opened without a tool.

Example:



Security Level

1	2	3	4
----------	----------	----------	----------

Limited Access - Tool is required

Example:



Security Level

1	2	3	4
----------	----------	----------	----------

Limited Access - Lockable

Example:

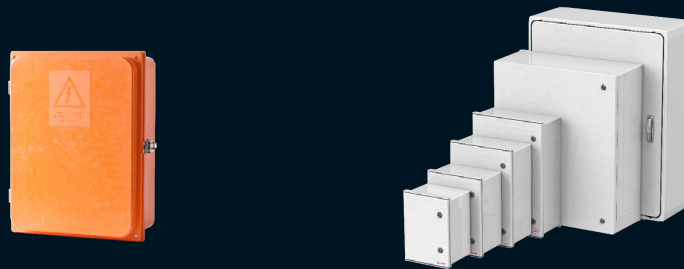

Security Level

1	2	3	4
----------	----------	----------	----------

Limited Access - Lockable/Vandal Resistant/Remote Access control/Monitoring

Example:



Enclosures

Hinges

Locks

Handles

Accessories

Rotary Operating Handles

Insulators

Transformer Equipment

Index

Allbro and Smartlock are South African companies that are leaders in their respective fields. In 2014 the companies entered into a partnership that would radically improve the security, cost, speed of deployment and monitoring of Manholes for fibre networks.

The range of fibre management housings is now arguably the most advanced offering of its kind in the world.

Modular Manhole Systems

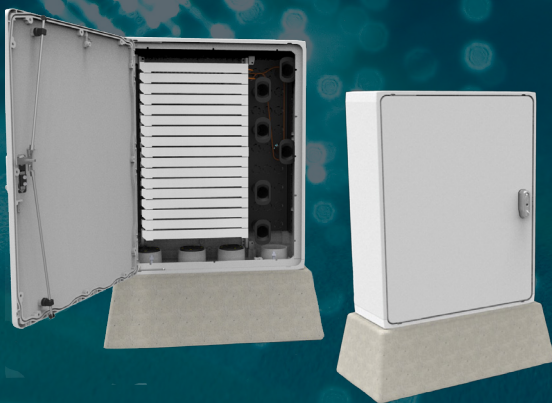
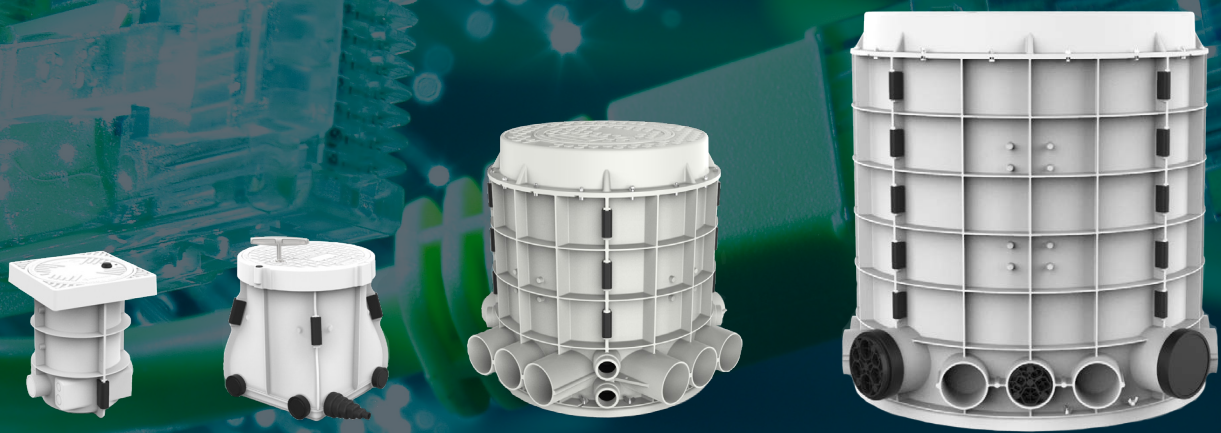

SDC - Street Distribution Cabinet

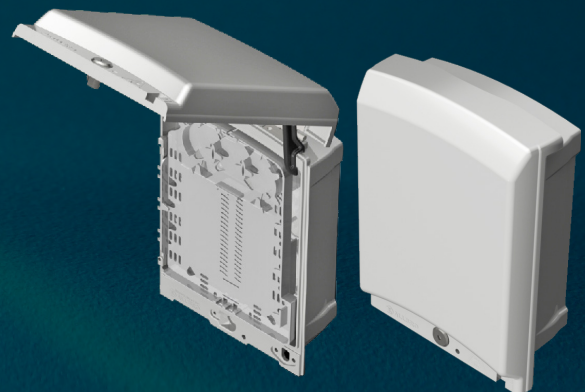

Tilt 2 Fibre - Universal Splicing Box

Enclosures

Hinges

Locks

Handles

Accessories

Rotary Operating
Handles

Insulators

Transformer
Equipment

Index

RHI-NODE 1000

The Rhi-Node 1000 is the largest access chamber in the range, designed to address all the functional requirements for deployment in Telecommunications and Utility infrastructure applications. Integrated access management and a robust vandal proof non-metal design adheres to all operational and environmental requirements. The units modular design allows for flat packaging that increases ease of handling and transportation to site as well as on site adjustments without the loss of structural integrity.

HEAVY DUTY APPLICATION

SERVICE HOLE ENTRIES:

4 x 160mm Split Duct entry

12 x 110mm Duct entry



Daylight Opening: 650mm
 Depth: 1000mm
 Weight: 100kg
 Load Rating: EN-124B125(125kN)
 SANS 558 HD (135kN)



Enclosures

Hinges

Locks

Handles

Accessories

Rotary Operating
Handles

Insulators

Transformer
Equipment

Index

Enclosures

Hinges

Locks

Handles

Accessories

Rotary Operating
Handles

Insulators

Transformer
Equipment

Index

RHI-NODE 600

The Rhi-Node 600 is designed to address all the functional requirements for deployment in Telecommunications and Utility infrastructure applications. Integrated access management and a robust vandal proof non-metal design adheres to all operational and environmental requirements. The unit is manufactured in a quick assemble flat pack configuration for ease of handling and transportation. The result is a modular, high strength, quality solution that addresses all end user requirements.

MEDIUM DUTY APPLICATION

SERVICE HOLE ENTRIES:

- 8 x 50mm Split Duct entry
- 12 x 110mm Duct entry
- 12 x 110mm Duct entry

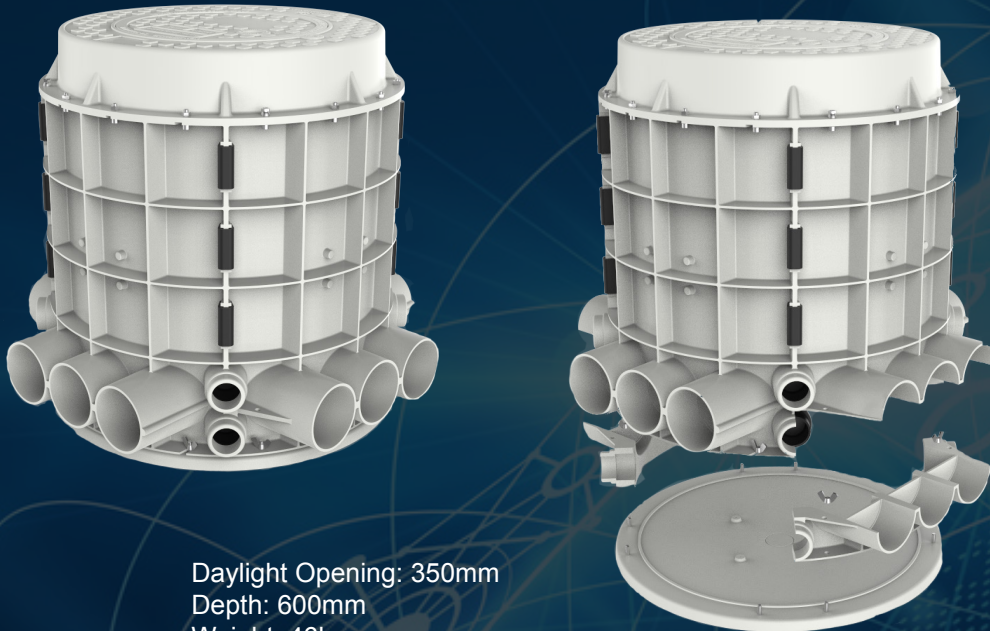

Daylight Opening: 350mm
 Depth: 600mm
 Weight: 46kg
 Load Rating: SANS 558 MD (40kN)

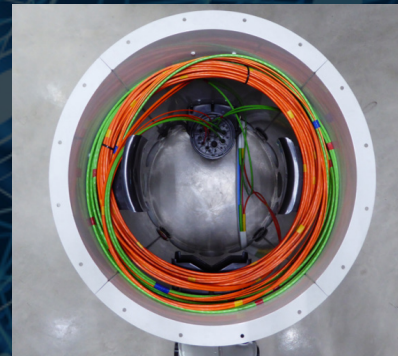

RHI-NODE 400

The Rhi-Node 400 is a high performing cost effective chamber solution aimed at the telecommunication and utility markets. Its modular design achieves flat packaging resulting in ease of handling and transportation whilst maintaining structural integrity under load when assembled. The chamber's on-site assembly capabilities provide for split entry installation over existing buried ducts and other services.

LIGHT DUTY APPLICATION

- For use in situations where wheeled vehicles have no access.
- Areas which can only be used by pedestrians and pedal cyclist

SERVICE HOLE ENTRIES:
8 x 50mm Split Duct entry



Daylight Opening: 310mm
Depth: 400mm
Weight: 8kg
Load Rating: EN-124 A15(15kN)
SANS 558 LD (7kN)

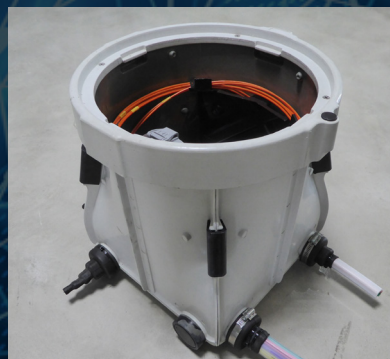

Enclosures

Hinges

Locks

Handles

Accessories

Rotary Operating
Handles

Insulators

Transformer
Equipment

Index

RHI-NODE 300

The Rhi-Node 300 is a unique and revolutionary solution specially designed for the fibre to home industry. Key design components include functional, operational and environmental requirements, in a robust vandal proof non-metal solution. Units are lightweight, easy to handle and assemble. Knockout holes enables users to modify units to suit their specific needs whilst maintaining its strength.

LIGHT DUTY APPLICATION

- For use in situations where wheeled vehicles have no access.
- Areas which can only be used by pedestrians and pedal cyclist

SERVICE HOLE ENTRIES:

- 2 x 50 mm entries
- 4 x 26 mm entries
- 4 x 21 mm entries



Daylight Opening: 200mm
 Depth: 300mm
 Weight: 5kg
 Load Rating: EN-124 A15(15kN)
 SANS 558 LD (7kN)

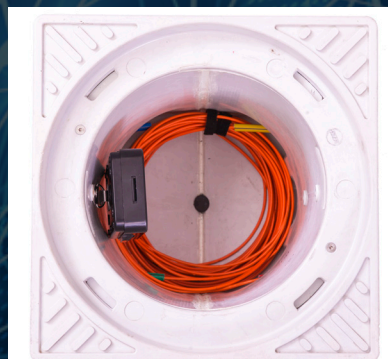

SMC STREET DISTRIBUTION CABINET(SDC)

A complete fiber distribution cabinet



TECHNICAL SPECIFICATIONS

Dimensions	(L) 1 000 X (W) 800 X (H) 320mm
Internal Mountable Capacity	17U - 19 inch
Security & Access	GLAM Swing handle lock
Lock Options	1 or 3 Point option
IP Rating	65
Installation Type	Indoor & Outdoor
Material	SMC (Sheet Moulding Compound)
Colour	Light Grey

THE GLAM SYSTEM

The GLAM (Gridlock Access Management) system is a centralised access management application authorizing access requests to remote locations, which have been equipped with electronic locking devices.

FEATURES & BENEFITS

- SMC Material
- Lightweight & Durable
- Internal metal parts - 304 Stainless Steel
- Bend Curve Management
- Adjustable Slack Management
- 4 x 110mm Entry Knock-outs
- Various Compression Glands - Optional
- Plinth or Wall Mountable
- Easy Installation
- Inland and Coastal application
- UL 94 Flammability Compliant
- UV Stabilised



Enclosures

Hinges

Locks

Handles

Accessories

Rotary Operating Handles

Insulators

Transformer Equipment

Index

THE GLAM LOCK SYSTEM

Robust electronic lock enabling the access management solution.



Enclosures

Hinges

Locks

Handles

Accessories

Rotary Operating Handles

Insulators

Transformer Equipment

Index

PRODUCT OVERVIEW

The GLAM lock is an encapsulated electronic dead lock. It requires no power connection or communication infrastructure to operate. This device is water, dust and grit proof, contains no active energy source and is certified to IP67. It is housed in ABS plastic which makes maintenance free and provides high physical strength. This device is also resistant to a wide range of chemicals.

The GLAM lock uses proven technology and large numbers have been installed in the harshest and remote environments with high reliability. The GLAM lock can be customised for a wide variety of access management applications.

TECHNICAL SPECIFICATIONS

Construction	ABS plastic housing with potted electronics.
Dimensions	(L) 80 X (W) 80 X (H) 60mm
Environmental	Tested to IEC 60068-2 and IEC 60529
Operating temperature	-10°C to 55°C
Ingress protection	IP67
Drop and Impact	1m and 20.0 Joule.
Power Source	None, powered via inductive circuit from Smart key.

LOCK FEATURES

- Compact design to minimize space requirements.
- Adaptable to suit a wide range of applications.
- Maintenance free.
- High grade stainless steel locking pin.





Part Number	Description	H (mm)	W (mm)	D (mm)
040-951	Tilt 2 Fibre Splicing Box	255	185	95

BENEFITS & FEATURES

- SMC Material-Lightweight & Durable.
- PC ABS Internal Parts.
- Cable management and routing limits bend radius and adds strain relief.
- Splicing and Patching.
- Ergonomic Design.
- Lockable for extra security.
- Pole or wall mountable.
- Easy Access to connectors for service and maintenance.
- Easy Installation - No Special tools required.
- UV Stabilised.
- UL94 Flammability Compliant.

TECHNICAL SPECIFICATIONS

Splices (Max)	40
Heatshrink Splices Holders (Max)	20 Double layer (40mm Splice Protector)
Splice Trays	1
Fibre Capacity	24 Fibre - 12 Way Drop
Fibre Entry	Oval, Plus 1
Fibre Drop	12 (3-5mm)
Slack Capacity	2m + Drop Cable
Splitter Capacity	2 off (1x2 up to 1x32)
Patching	12LC Duplex/ SC Simplex
IP Rating	54
Installation Type	Indoor & Outdoor
Material	SMC (Sheet Moulding Compound)
Colour	Light Grey

Enclosures

Hinges

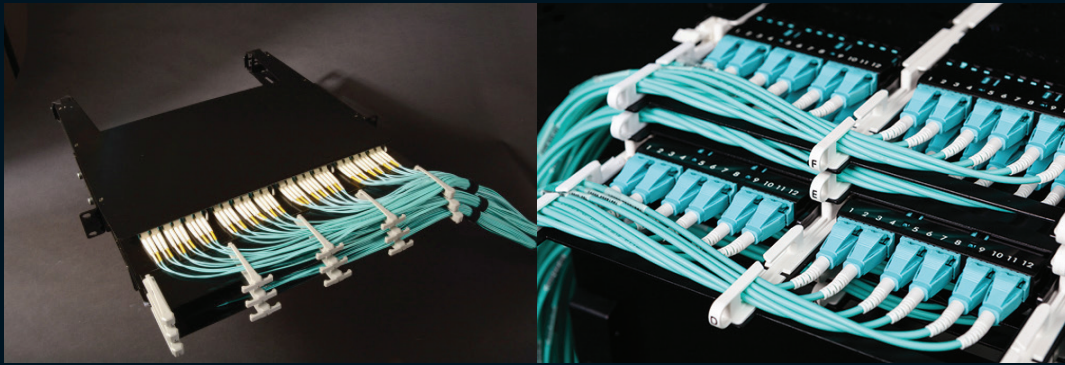

* Examples of similar applications

Locks

Handles

Accessories

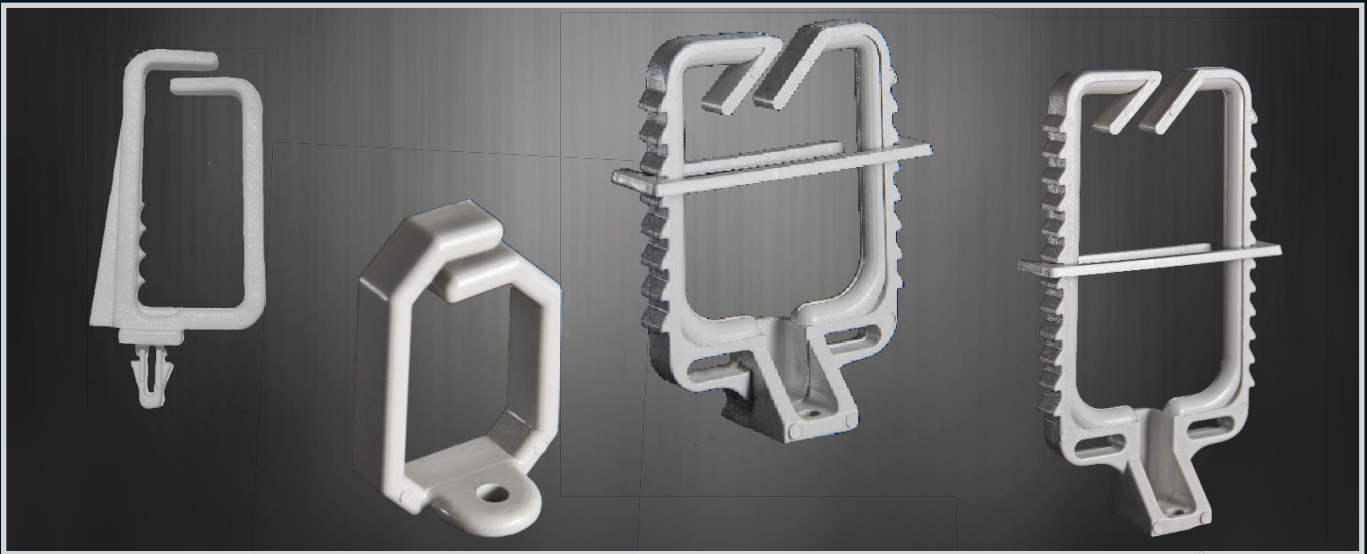

Part Number	Description	H (mm)	W (mm)	D (mm)
FTP-0002	100 PR Jumper Guide Clip	51	32	7
FTP-0004	100 PR Jumper Guide	40,5	28,3	8.1
FTP-0006	300 PR Jumper Guide	95	61	8
FTP-0008	600 PR Jumper Guide	70	61	8

Rotary Operating Handles

Insulators

Transformer Equipment



Part Number	Description
FTP-0010	RJ45 - Single Wall Outlet
FTP-0011	RJ45 - Double Wall Outlet

Index

Notes:

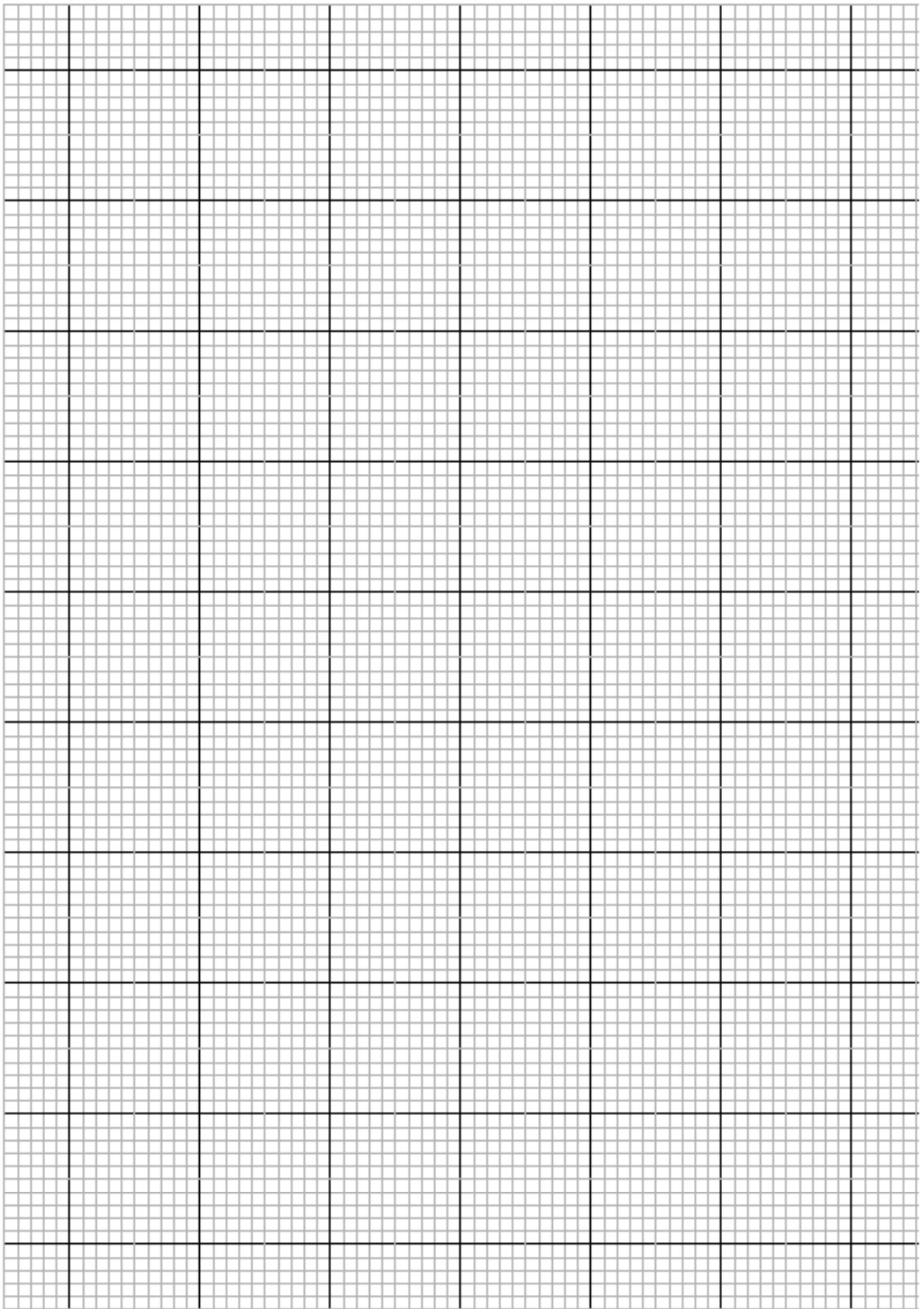



Mounting does NOT affect IP level
(Many enclosures require drilling which compromises IP level)



1/4 Turn Stainless steel screws

(Self tapping screws that deteriorate the plastic or plastic screws they mount for which are not durable)



18 Different sizes
(Widest range in South Africa)

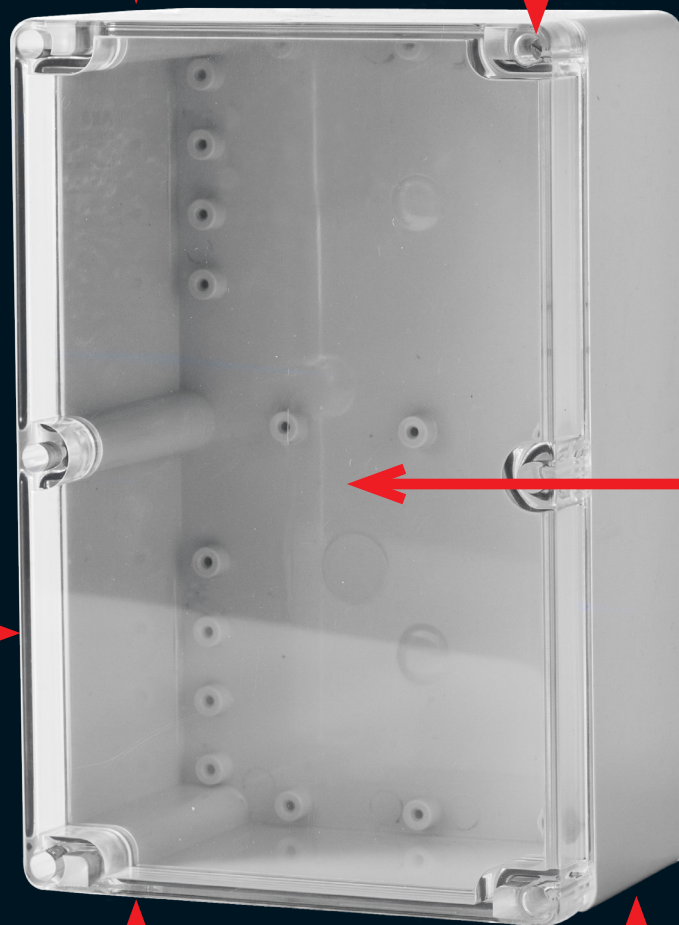

Clean surface for mounting equipment or labels unlike other plastic enclosures that have unsightly spew/injection marks

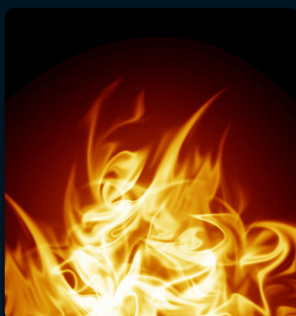

Flame Retardant High Quality Polycarbonate Material
(Base & Lid)
See UL 94 (V0) and Needle Flame (V0) on page 10



Halogen Free

Enlec® Features

Polycarbonate enclosures for electronic & electrical applications



Material	Polycarbonate			
Operating Temperature	- 20°C to + 110°C			
Glow Wire Capability / Flammability	960° / UL94 V0			
Expected UV Life (Direct Exposure)	5-8 years (10-15 years - Indirect Exposure)			
IP Level	IP66			
IK Level	IK10			
Security Level	1	2	3	4

Enclosures

Hinges

Locks

Handles

Accessories

Rotary Operating Handles

Insulators

Transformer Equipment

Index

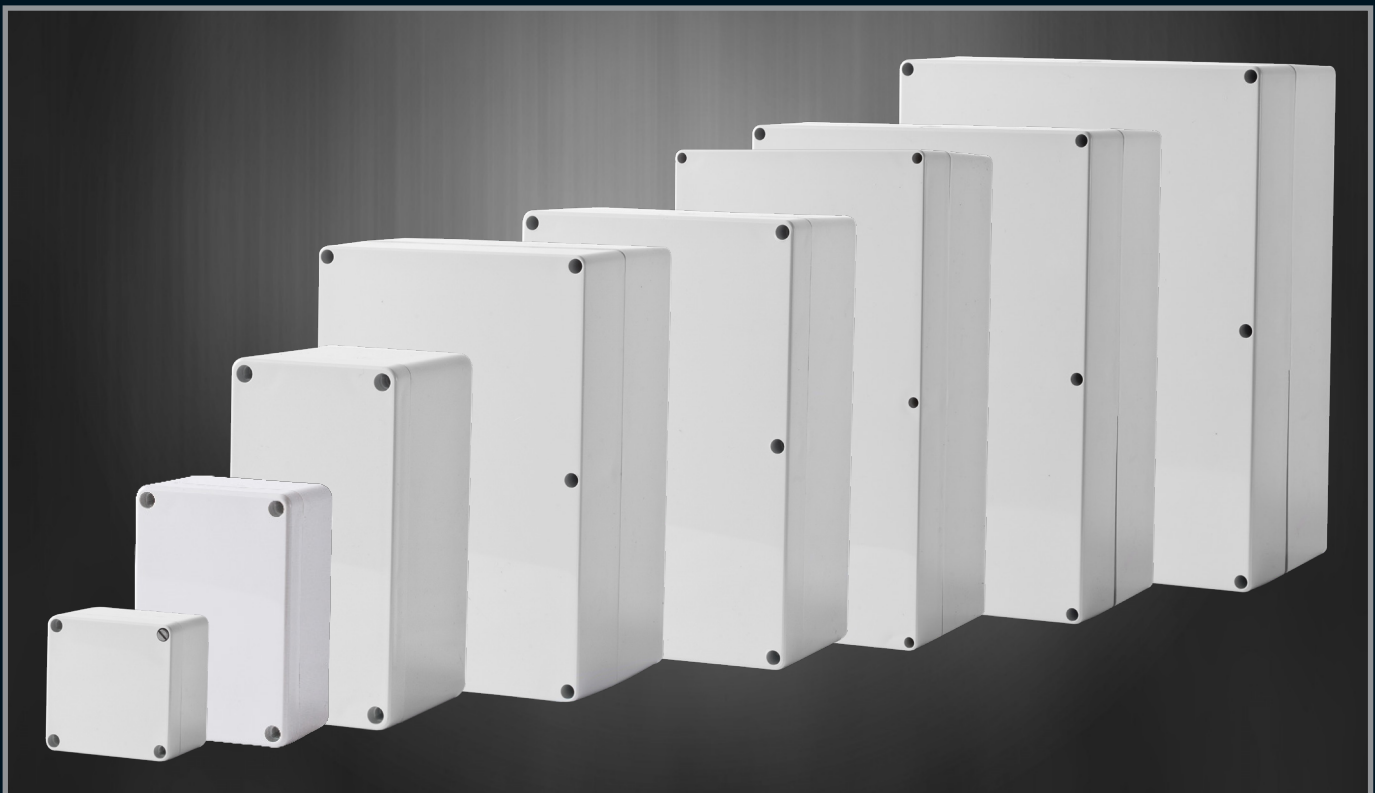

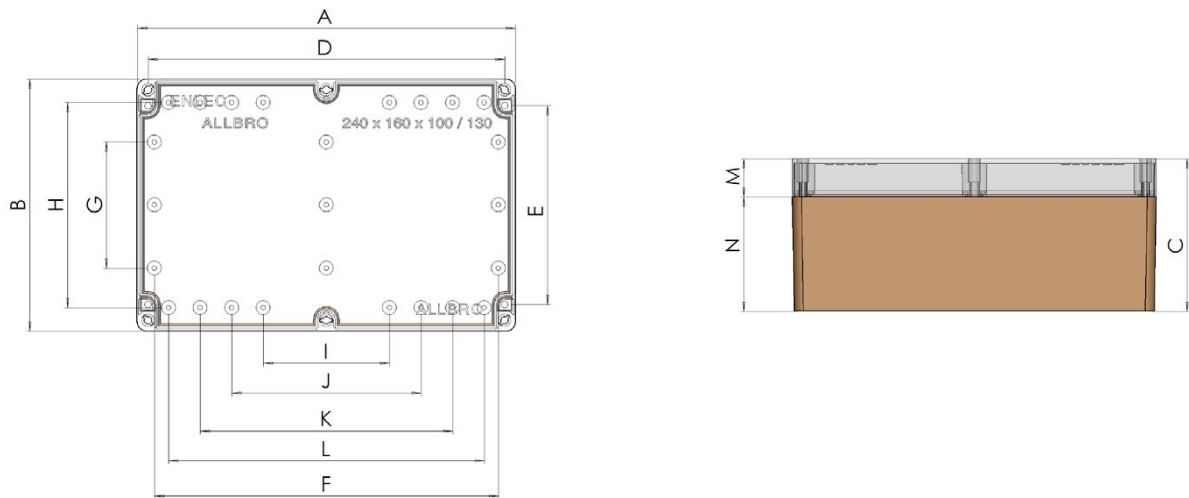

External Dimensions (mm)			Internal Dimensions (mm)											Part Number		
A (Height)	B (Width)	C (Depth)	D	E	F	G	H	I	J	K	L	M	N	Clear Lid IP66	Grey Lid IP66	Device Plate Sold Separately
80	80	55	68	50	58	N/A	58	N/A	N/A	N/A	40	15	40	ENL080806C	ENL080806P	ENL0808DP
120	70	50	89	57	74	N/A	46	NA	N/A	N/A	52	15	35	ENL120705C	ENL120705P	N/A
120	80	55	106	46	96	N/A	58	N/A	N/A	40	80	15	40	ENL120806C	ENL120806P	ENL1208DP
120	80	90	106	46	96	N/A	58	N/A	N/A	40	80	15	75	ENL120809C	ENL120809P	ENL1208DP
120	120	55	106	86	100	40	98	N/A	N/A	N/A	80	15	40	ENL121206C	ENL121206P	ENL1212DP
120	120	90	106	86	100	40	98	N/A	N/A	N/A	80	15	75	ENL121209C	ENL121209P	ENL1212DP
160	80	55	146	46	136	N/A	58	N/A	N/A	60	120	15	40	ENL160806C	ENL160806P	ENL1608DP
160	80	90	146	46	136	N/A	58	N/A	N/A	60	120	15	75	ENL160809C	ENL160809P	ENL1608DP
160	120	90	146	86	136	N/A	90	N/A	N/A	N/A	120	15	75	ENL161209C	ENL161209P	ENL1612DP
160	160	90	146	126	140	80	130	N/A	N/A	N/A	120	15	75	ENL161609C	ENL161609P	ENL1616DP
200	120	90	186	86	176	40	90	N/A	N/A	116	160	15	75	ENL201209C	ENL201209P	ENL2012DP
200	150	90	186	116	N/A	56	118	N/A	N/A	80	160	15	75	ENL201509C	ENL201509P	ENL2015DP
240	120	100	226	86	218	40	90	80	120	160	200	25	75	ENL241210C	ENL241210P	ENL2412DP
240	160	100	226	126	218	80	130	80	120	160	200	25	75	ENL241610C	ENL241610P	ENL2416DP
240	160	130	226	126	218	80	130	80	120	160	200	55	75	ENL241613C	ENL241613P	ENL2416DP
300	230	100	286	196	278	150	200	140	180	220	260	25	75	ENL302310C	ENL302310P	ENL3023DP
300	230	130	286	196	278	150	200	140	180	220	260	55	75	ENL302313C	ENL302313P	ENL3023DP
360	200	150	346	166	338	120	170	200	240	280	320	50	100	ENL362015C	ENL362015P	ENL3620DP

Part Number	Description
ENL-H	ENL-Hinges
ENL-M	ENL-Mounting Feet
ENL-4	ENL-2 Set 4 Screw Combo
ENL-6	ENL-6 Set Screw Combo



Notes:

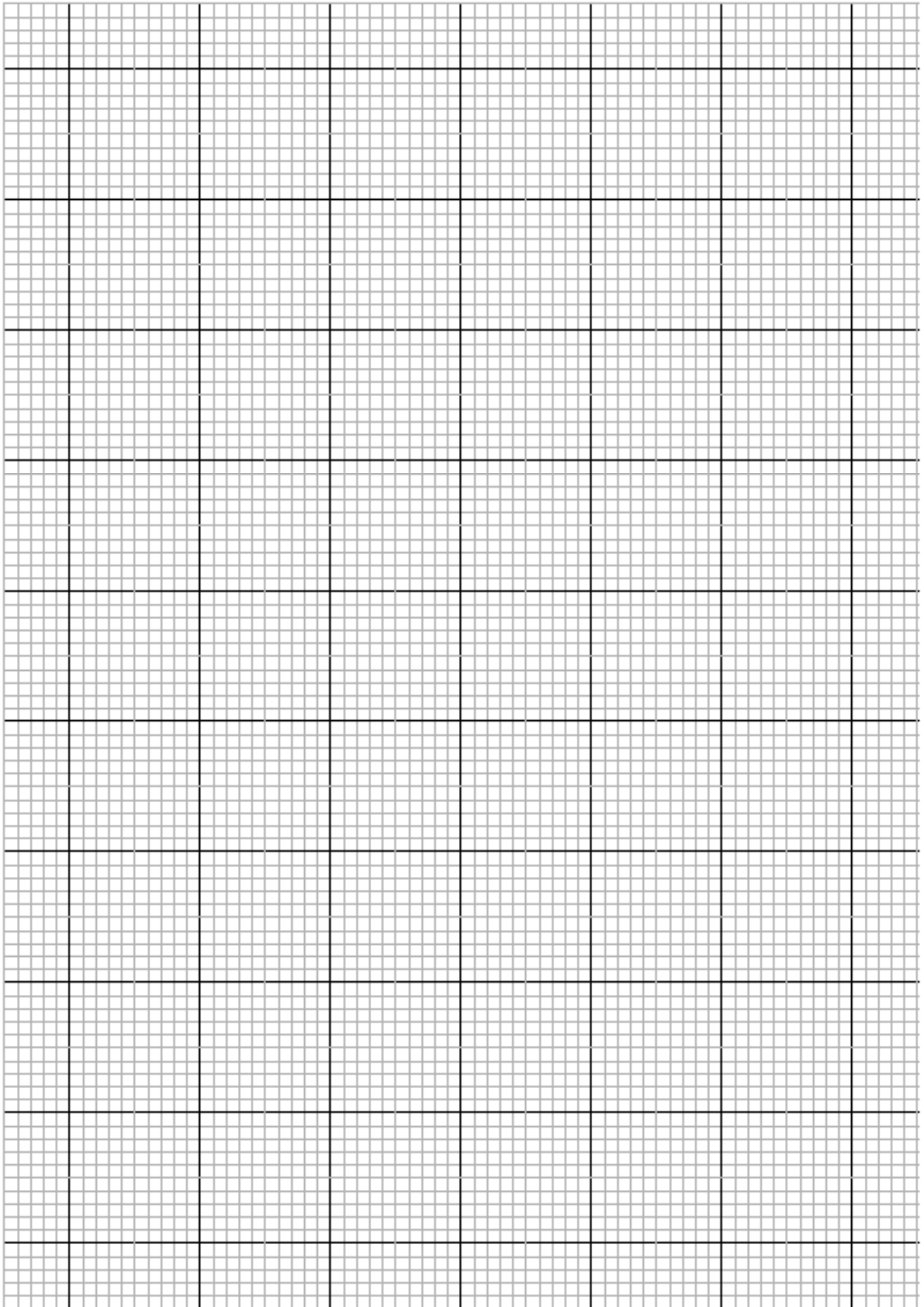

Enclosures

Material	DMC (Dough Moulding Compound)			
Operating Temperature	-50° C to + 200° C			
Glow Wire Capability / Flammability	960° / UL94 V0			
Expected UV Life (Direct Exposure)	25 years +			
IP Level	IP66			
Security Level	1	2	3	4

Hinges

Allbro has launched the very first camera enclosure of its kind. Designed and made in South Africa the Camera-Den addresses the unique challenges of this application in a manner that has never been done before. Once one lays eyes upon Allbro's new "Camera Den" it becomes difficult to even call the new invention a camera box.

Locks

Handles

Accessories



Rotary Operating Handles

Insulators

Transformer Equipment

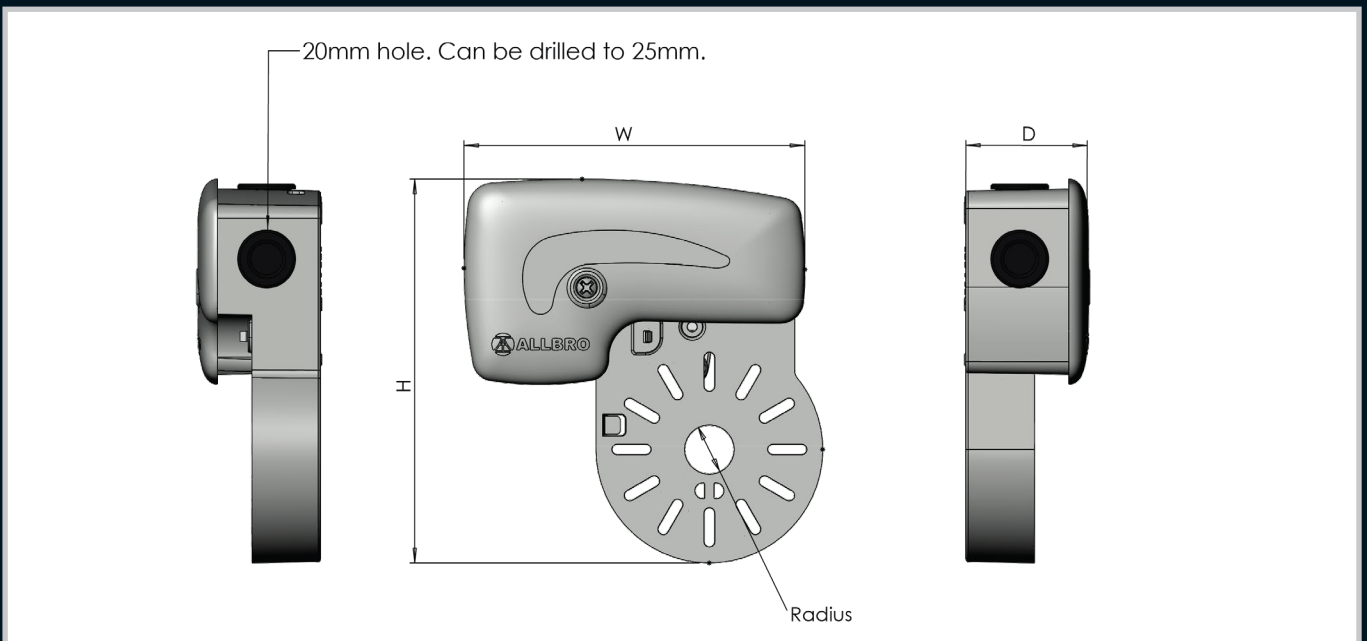

Index

Part Number	Description	H (mm)	W (mm)	D (mm)	Radius (mm)
040-958	Camera-Den Complete 90mm	156	139	51	20
040-977	Camera-Den Complete 110mm	174	139	51	53.3

INSTALLATION:

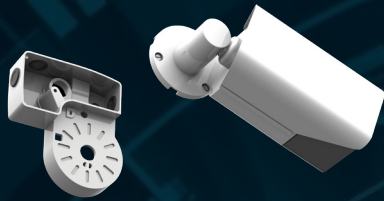

Step 1: Mount the camera on the Camera-Den™ whilst safely on the ground



Step 2: Mount bracket on the wall.
(NB 6mm Screw/Plug Not Included)

NOTE: RECOMMENDED TORQUE FOR LID & MOUNTING BRACKET SCREWS - 1,5Nm --> 2,5Nm



Step 3: Hook unit on the bracket and test/adjust the camera with a tester. All Connections accessible remain.

Step 4: Connect camera wires and close the unit with the cap. The Camera Den is IP 66 and has a UV Life of 25 years

Step 1 continued:

① Place camera onto the Camera-Den™. Pull the camera cables through the hole in the middle of the base.

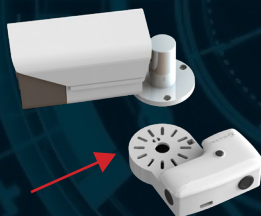

② Place Allbro stretch grommet over the camera fitting.

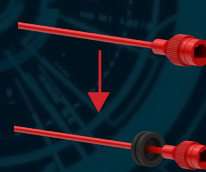

Allbro grommet stretches over most camera fittings

③ Cable tie the cable (A) and feed the rest of the fitting through opening (B).

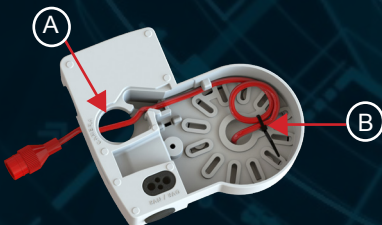

④ Place grommet back to secure cable in place and protect the cabling from water seeping in.



⑤ Close the opening in STEP 3 with cap provided.

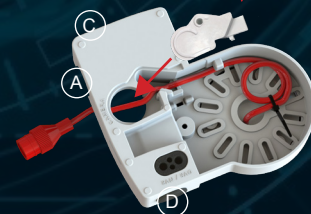

⚠ Please Note:

* Outer blank plugs (A, B & C) can be removed where applicable for cable glands of conduit fittings.

These blanks are NOT intended for use as cable grommets.

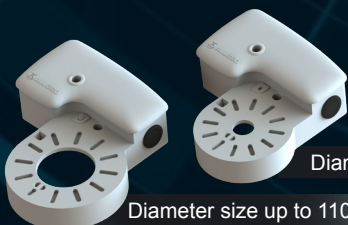

Diameter size up to 90mm

Diameter size up to 110mm

CAMERA-DEN™ IS AVAILABLE IN TWO SIZES

Designed to accommodate most camera brands & sizes!

Enclosures

Hinges

Locks

Handles

Accessories

Rotary Operating Handles

Insulators

Transformer Equipment

Index



GRP Material
(Proven to lasts decades in the African sun)



External mounting feet
(Separate Accessory)



Halogen free

Halogen Free



11 Different sizes

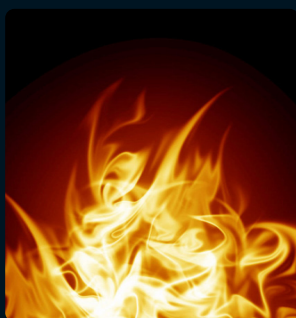

Flame Retardant

**Slide Lid (IP 54)
Screw Lid (IP 65)**

Material	DMC (Dough Moulding Compound)			
Operating Temperature	-50° C to + 200° C			
Glow Wire Capability / Flammability	960° / UL94 V0			
Expected UV Life (Direct Exposure)	25 years +			
IP Level	IP54 for slide lid application, IP65 for screw lid application			
IK Level	IK8			
Security Level	1	2	3	4

Enclosures

Hinges

Locks

Handles

Accessories

Rotary Operating Handles

Insulators

Transformer Equipment

Index

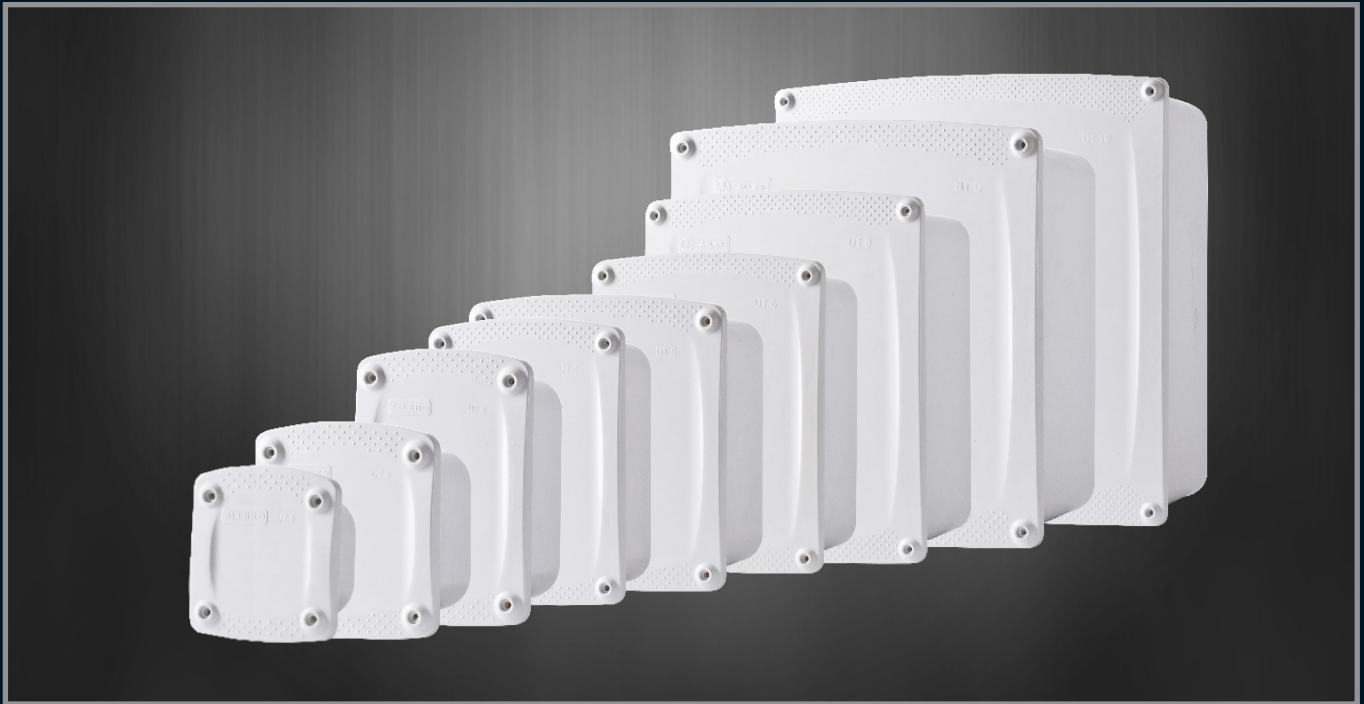

Note: Why slide lid? No gasket is used, so less chance of deterioration over extended use. Lifespan of IP level is increased.

- Enclosures
- Hinges
- Locks
- Handles
- Accessories
- Rotary Operating Handles
- Insulators
- Transformer Equipment
- Index



Part Number	Description
UT-MF	UT Mounting Feet
UT4-DIN	UT4 Shroud Kit
UT4-SAM	UT4 Shroud 6 Way Samite
UT6-DIN	UT6 Shroud 8 Way Din
UT6-SAM	UT6 Shroud 11 Way Samite
UT10-DIN	UT10 Shroud 24 Way Din
UT10-SAM	UT10 Shroud 32 Way Samite

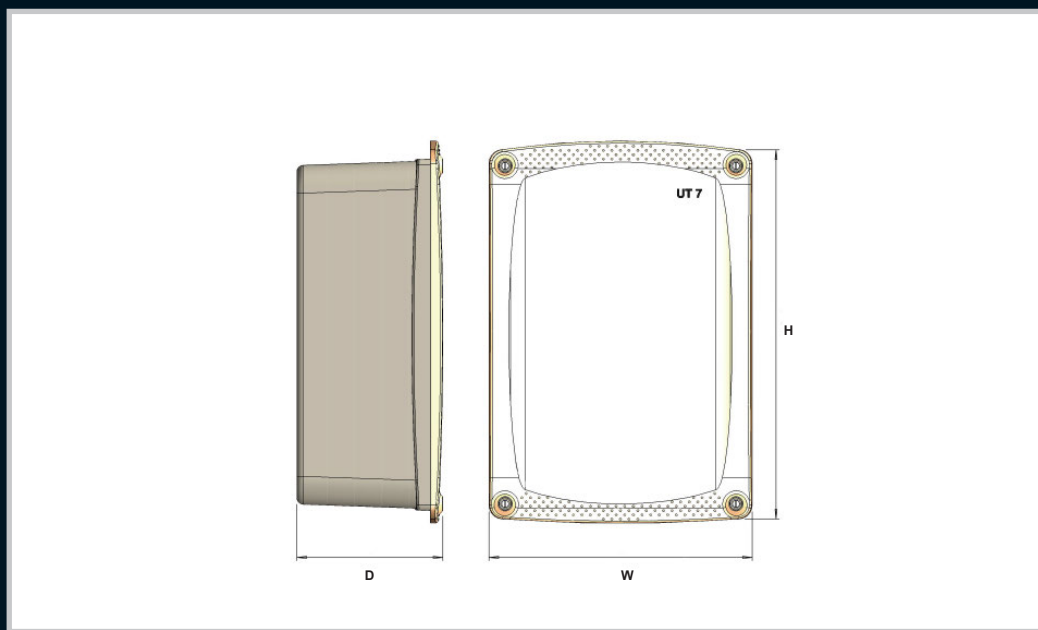

	Internal Dimensions (mm)			External Dimensions (mm)			Screw Lid IP65	Slide Lid IP54	Qty per box	Device Plate Sold Separately
	H1	W1	D1	H	W	D	Part Number	Part Number		Part Number
UT1	80	80	60	122	110	70	040-751	040-752	10	DEV-UT1
UT2	110	110	90	155	144	100	040-655	040-714	9	DEV-UT2
UT3	160	110	90	204	144	100	040-670	040-715	8	DEV-UT3
UT4	210	160	90	253	194	100	040-656	040-716	8	DEV-UT4
UT4 -D	211	160	180	253	194	186	040-753	040-761	6	DEV-UT4
UT5	210	210	125	257	246	136	040-657	040-717	6	DEV-UT5
UT6	260	210	125	307	246	136	040-658	040-718	4	DEV-UT6
UT7	310	210	125	357	246	136	040-671	040-719	4	DEV-UT7
UT8	310	260	165	359	298	176	040-672	040-720	2	DEV-UT8
UT9	310	310	165	359	348	176	040-673	040-721	2	DEV-UT9
UT10	410	410	165	459	448	176	040-674	040-722	2	DEV-UT10

Material	ABS Plastic			
Operating Temperature	-30° C to + 90° C			
Glow Wire Capability / Flammability	650° / UL94 HB (Flammable)			
Expected UV Life (Direct Exposure)	2-3 Years (6 Years - Indirect exposure)			
IP Level	IP55			
Security Level	1	2	3	4

Enclosures

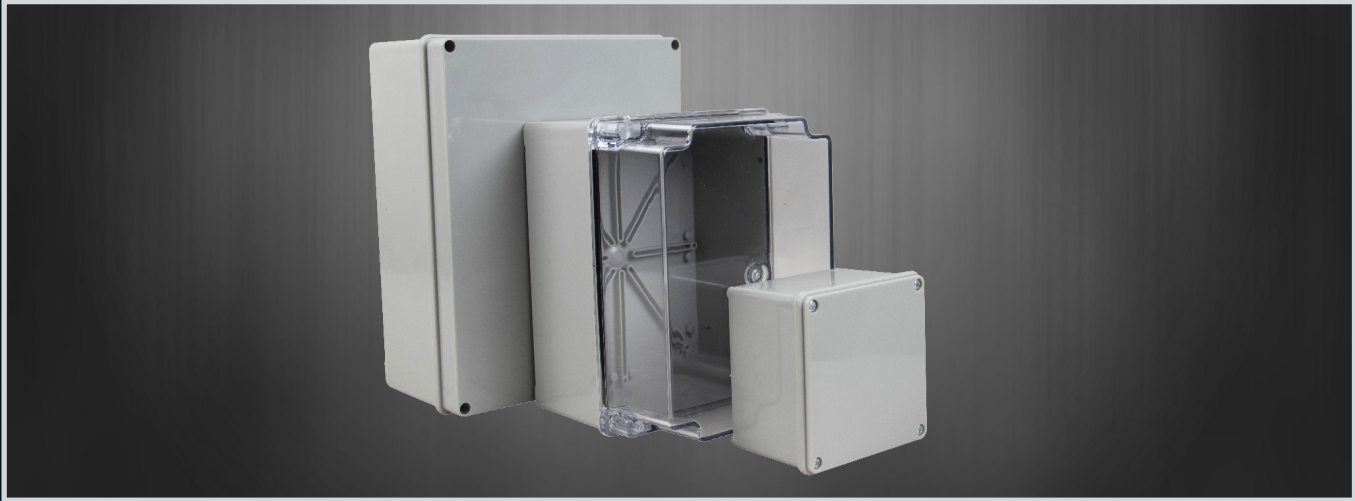

Hinges

Locks

Handles



Accessories

Part Number	Description	H (mm)	W (mm)	D (mm)	Qty per box
FEP-0014	ABS Enclosure - Standard Grey Lid	100	100	70	80
FEP-0016	ABS Enclosure - Standard Grey Lid	100	100	90	60
FEP-0015	ABS Enclosure - Standard Transparent Lid	100	100	70	80
FEP-0017	ABS Enclosure - Standard Transparent Lid	100	100	90	60

Rotary Operating Handles



Insulators

Part Number	Description	H (mm)	W (mm)	D (mm)	Qty per box
FEP-0022	ABS Enclosure - Standard Grey Lid	190	140	90	20
FEP-0024	ABS Enclosure - Deep Grey Lid	190	140	135	16
FEP-0023	ABS Enclosure - Standard Transparent Lid	190	140	90	20
FEP-0025	ABS Enclosure - Deep Transparent Lid	190	140	135	16

Transformer Equipment



Index

Part Number	Description	H (mm)	W (mm)	D (mm)	Qty per box
FEP-0026	ABS Enclosure - Standard Grey Lid	240	190	100	10
FEP-0028	ABS Enclosure - Deep Grey Lid	240	190	155	4
FEP-0027	ABS Enclosure - Standard Transparent Lid	240	190	100	10

- Enclosures
- Hinges
- Locks
- Handles
- Accessories
- Rotary Operating Handles
- Insulators
- Transformer Equipment
- Index

Material	DMC (Dough Moulding Compound)
Operating Temperature	-50° C to + 200° C
Glow Wire Capability / Flammability	960° / UL94 V0
Expected UV Life (Direct Exposure)	25 years +
IP Level	IP54
IK Level	IK8
Security Level	With RL the security level differs between products. Please note individual security rating.

RL and AP series enclosures preceded the more modern range of enclosures we call Allbrox. Although superseded for the most part, there are still some applications where these tried and tested versions are preferred. Please check availability and lead times when ordering.



Security Level: 2

Part Number		H (mm)	W (mm)	D (mm)	Description	Qty per box
040-727	RL-1P	166	166	106	Plain (Screw fastened Lid)	20
040-726	RL-1HW/L	166	176	106	Hinged with window	20
040-725	RL-1HP	166	176	106	Hinged plain box	20



Security Level: 2

Part Number		H (mm)	W (mm)	D (mm)	Description	Qty per box
040-730	RL-2P	222	165	108	Plain (Screw Fastened Lid)	4
040-728	RL-2HP	222	175	108	Hinged plain box	4
040-729	RL-2HW	222	175	108	Hinged with window	4
040-766	RL-2CP	222	165	180	Plain (Screw Fastened Lid)	4
040-764	RL-2CHP	222	174	180	Hinged plain box	4
040-765	RL-2CHW	222	174	180	Hinged with window	4

Note: C = Deep Base, Shallow Lid



Security Level: 2

Part Number		H (mm)	W (mm)	D (mm)	Description	Qty per box
040-769	RL-3P	260	239	236	Plain (Screw fastened Lid)	3
040-767	RL-3HP	284	248	236	Hinged plain box	3
040-768	RL-3HW	284	248	236	Hinged with window	3



Security Level: 2

Part Number		H (mm)	W (mm)	D (mm)	Description	Qty per box
040-733	RL-4P	371	269	165	Plain (Screw fastened Lid)	2
040-731/L	RL-HP	371	277	169	Hinged plain with latch	2
040-732/L	RL-4HW	371	276	165	Hinged window with latch	2
040-734	RL-4DHP	371	277	216	Hinged Deep plain box	4
040-735	RL-4DHW	371	277	216	Hinged with window Deep	4

Note: Special wired pole mounted enclosures available on request.

RL - Series

RL and AP series enclosures preceded the more modern range of enclosures we call Allbrox. Although superseded for the most part, there are still some applications where these tried and tested versions are preferred. Please check availability and lead times when ordering.



Security Level: 3

Part Number		H (mm)	W (mm)	D (mm)	Description	Qty per box
040-738	RL-5P	413	319	204	Plain (Screw fastened Lid)	3
040-736/L	RL-5HP	413	332	207	Hinged plain with latch	3
040-737/L	RL-5HW	413	319	207	Hinged window with latch	3
040-741	RL-5BP	422	328	140	Plain (Screw fastened Lid)	3
040-739	RL-5BHP	422	328	143	Hinged plain box	3
040-740	RL-5BHW	422	337	143	Hinged with window	3

Note: B = Shallow Lid
Orange colour available on request - used here for illustration only.
Standard colour is GREY.



Security Level: 3

Part Number		H (mm)	W (mm)	D (mm)	Description	Qty per box
040-640	RL-6D-P	480	343	210	Hinged plain box deep	1



Security Level: 3

Part Number	Description	H (mm)	W (mm)	D (mm)	Qty per box
AP2-A	AP2-A (DB-1 Shallow)	600	450	165	1



Security Level: 3

Part Number	Description	H (mm)	W (mm)	D (mm)	Qty per box
AP3-A	AP3-A (DB-1 Deep)	600	450	260	1
AP3-S	AP3-S (DB-1T Box - Thin)	600	450	75	1



Part Number	Description	H (mm)	W (mm)	D (mm)
020-293	PB-small B-A	27	124	22
020-292	PB-medium B-B	31	147	30
020-291	PB-large B-C	27	250	55
020-081	DMC DEVICE PLATE RL2 (DEV-D)	200	140	3
020-082	DMC DEVICE PLATE RL1 (DEV-C)	146	145	3
020-083	DMC DEVICE PLATE RL3A (DEV-G)	255	215	3
020-084	DMC DEVICE PLATE RL3 (DEV-H)	255	215	4
020-085	DMC DEVICE PLATE RL4 (DEV-O)	345	240	4
020-086	DMC DEVICE PLATE RL5 (DEV-Q)	385	289	3

Enclosures

Hinges

Locks

Handles

Accessories

Rotary Operating Handles

Insulators

Transformer Equipment

Index



Weather & UV Resistant
(25 Year outdoor life)



Halogen Free



External mounting system ensures IP level is not compromised



Flame Retardant

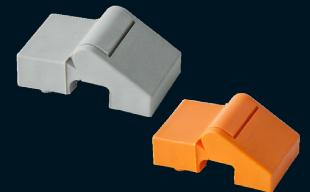

External Hinges can be added

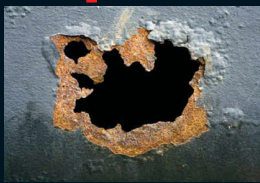

Durable GRP Material



Can be Colour Impregnated

Material	DMC (Dough Moulding Compound)			
Operating Temperature	+200°C on DMC lids and +110°C on Polycarbonate Lids			
Glow Wire Capability / Flammability	960° / UL94 V0			
Expected UV Life (Direct Exposure)	25 years +			
IP Level	IP68			
IK Level	IK9			
Security Level	1	2	3	4

Enclosures

Hinges

Locks

Handles



Dimensions (mm)			Base (mm)	Lid (mm)	7035 RAL Base		Orange Base		Qty per box	Device Plate (Sold Separately)	
H	W	D	D	D	Grey Lid	Clear Lid	Orange Lid	Clear Lid		SMC Version	Powder Coated Mild Steel
					IP 68	IP 68	IP 68	IP 68			
186	151	135	90	45	OK0-G	OK0-GC	OK0-O	OK0-OC	4	OKM-0	OKM-0M
280	185	180	135	45	OK1-G	OK1-GC	OK1-O	OK1-OC	4	OKM-1	OKM-1M
280	280	180	135	45	OK2-G	OK2-GC	OK2-O	OK2-OC	2	OKM-2	OKM-2M
370	280	180	135	45	OK3-G	OK3-GC	OK3-O	OK3-OC	2	OKM-3	OKM-3M
560	370	180	135	45	OK4-G	OK4-GC	OK4-O	OK4-OC	1	OKM-4	OKM-4M

Accessories

Rotary Operating Handles



Insulators



Accessories

Part Number	Description
OKPH-G	DMC Hinge Set -Grey
OKPH-O	DMC Hinge Set -Orange
OKM-MS	Stainless Steel Mounting Brackets
OK-BP	Blind Plug
AE116	Cover Sealing Screws
OKARI-HAND	Handle

Transformer Equipment

Index

Terminal Box Features

High impact enclosures for tough environments



Weather & UV Resistant
(25 Year outdoor life)



Halogen free

Halogen Free



Flame Retardant



17 Different sizes

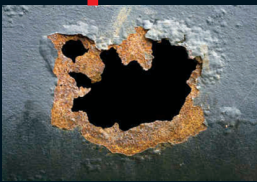

Durable GRP Material

 **Versions Available**



Terminal Boxes

High impact enclosures for tough environments



Material	DMC (Dough Moulding Compound)
Operating Temperature	-50° C to + 200° C
Glow Wire Capability / Flammability	960° / UL94 V0
Expected UV Life (Direct Exposure)	25 years +
IP Level	IP68
IK Level	IK9
Security Level	Security Level 1 for Round Enclosure and Security Level 2 for Square/Rectangle Enclosure



- Enclosures
- Hinges
- Locks
- Handles
- Accessories
- Rotary Operating Handles
- Insulators
- Transformer Equipment
- Index

Enclosures

UB40 & UB41 Enclosure



Hinges

Locks

Handles

External Dimensions (mm)			Internal Dimensions (mm)			Part Number	Description	IP Level	Qty per box
H	W	D	H	W	D				
115	115	83	90	90	70	040-702	UB40 (20mm)	68	20
140	140	90	124	124	78	040-793	UB41 (25mm)	68	20
115	115	83	90	90	70	040-702/TERM	UB40 (20mm) with terminals	68	20
140	140	90	124	124	78	040-793/TERM	U41 (25mm) with terminals	68	20

Accessories

Rotary Operating Handles

Insulators

Transformer Equipment

Index

UB40 Bottom Entry Enclosure



External Dimensions (mm)			Internal Dimensions (mm)			Part Number	Description	IP Level	Qty per box
H	W	D	H	W	D				
108	140	110	65	90	90	040-702/BE	UB40 Bottom Entry (20mm)	68	20
108	140	110	65	90	90	040-702/BE/TERM	Junction Box UB40/A1/20 (Bottom Entry) complete with Terminals	68	20

BENEFITS & FEATURES

- For general industrial and mining electrical installations.
- No exposed metal parts.
- Dust and waterproof IP68.
- No drilling or tapping of cable entries required.
- Internal earthing to all entries and rail provided.

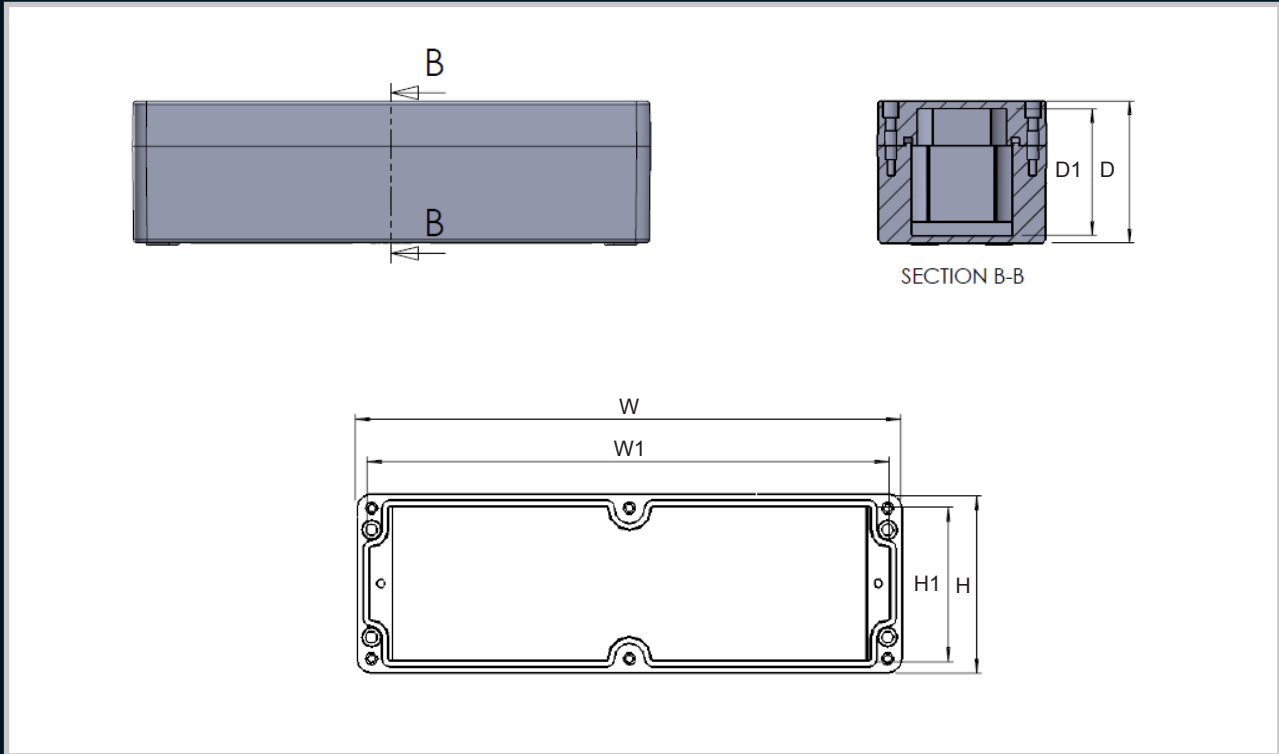

External Dimensions (mm)			Internal Dimensions (mm)			Part Number		IP Level	Qty per box
H	W	D	H1	W1	D1	Black (Eex)	Grey		
75	80	61	65	70	56	0808KE/I	0808POK/I	68	10
75	110	64	65	100	54	0811KE/I	0811POK/I	68	10
75	160	61	65	150	54	0816KE/I	0816POK/I	68	10
75	190	61	65	180	54	0819KE/I	0819POK/I	68	10
75	230	63	65	220	54	0823KE/I	0823POK/I	68	10
120	125	90	110	115	80	1212KE/I	1212POK/I	68	10
120	220	95	110	210	85	1222KE/I	1222POK/I	68	10
160	160	95	147	147	86	1616KE/I	1616POK/I	68	10
160	260	95	146	246	86	1626KE/I	1626POK/I	68	10
160	360	95	146	346	86	1636KE/I	1636POK/I	68	10
160	560	95	146	550	86	1656KE/I	1656POK/I	68	10
250	255	128	237	242	113	2526KE/I	2526POK/I	68	10
250	400	128	237	387	113	2540KE/I	2540POK/I	68	10
250	600	128	237	587	121	2560KE/I	2560POK/I	68	10
410	400	128	387	397	113	4140KE/I	4140POK/I	68	10
250	255	163	237	242	149	2526KE/DI	2526POK/DI	68	10
250	400	163	237	387	149	2540KE/DI	2540POK/DI	68	10

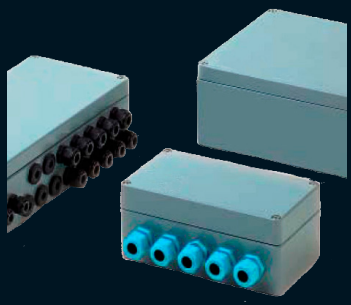

* Versions Available

Enclosures
Hinges
Locks
Handles
Accessories
Rotary Operating Handles
Insulators
Transformer Equipment
Index

Stealth access flaps can be used on any enclosure with a flat surface and has appropriate dimensions to accommodate such flaps. We have created some standardised solutions using AllRobust™ enclosures with Stealth Access flaps as well as AllTilt® enclosures with Stealth Access flaps.

Standard applications includes:

- Temporary power distribution board (pg.54)
- Pole mounted enclosures with MCB access or Keypad Access (pg.91)
- “Stand up” Pool Box™ (pg.81)
- AllRobust™ (pg.53)
- PSO1-Stealth™ (pg.76)
- Stealth Isolator Box (pg.79)
- ADB (pg.82)

Features of Stealth-Access flaps

IP66 Fully Waterproof



Optional PC Flap
*Not suitable for direct sunlight

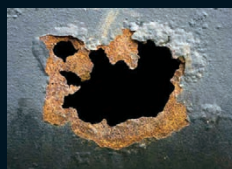

Durable GRP Material



Pad-Lockable

Lead Seal/ Tamper Seal



Description	Barrel Lock	Wing Lock
Hand Access Flap GRP Wing Lock Plastic		X
Hand Access Flap PC Wing Lock Plastic		X
Access Flap 4 way - GRP Lid Barrel Lock	X	
Access Flap 4 way - PC Lid Wing Lock Plastic		X
Access Flap 4 way - PC Lid Barrel Lock	X	
Access Flap 4 way - GRP Lid Wing Lock Plastic		X
8 Way Access Flap GRP - Lid Wing Lock Plastic		X
8 Way Access Flap - PC Lid Wing Lock Plastic		X
13 Way Access Flap - GRP Lid Barrel Lock	X	
13 Way Access Flap - GRP Lid Wing Lock Plastic		X
13 Way Access Flap - PC Lid Barrel Lock	X	
13 Way Access Flap - PC Lid Wing Lock Plastic		X

Enclosures

Hinges

Locks

Handles

Accessories

Rotary Operating Handles

Insulators

Transformer Equipment

Index

Enclosures
Hinges
Locks
Handles
Accessories
Rotary Operating Handles
Insulators
Transformer Equipment
Index

Material	SMC (Sheet Moulding Compound)			
Operating Temperature	-50° C to - 200° C			
Glow Wire Capability / Flammability	960° / UL94 V0			
Expected UV Life (Direct Exposure)	25 years +			
IP Level	IP66			
IK Level	IK10			
Security Level	1	2	3	4

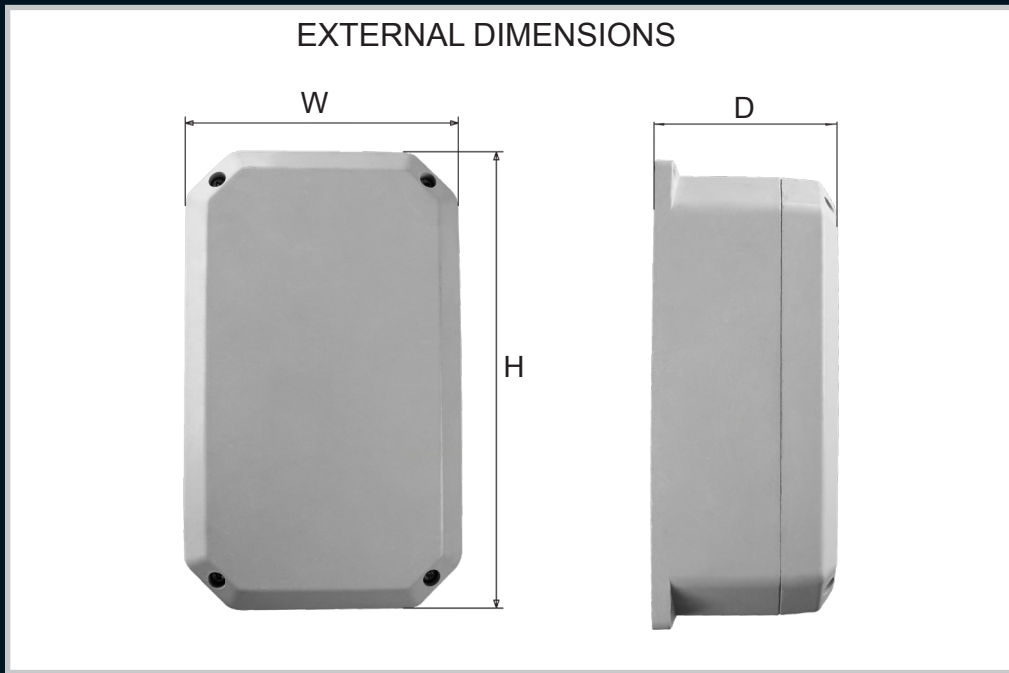

Part Number	Description	H (mm)	W (mm)	D (mm)
040-916	Robust 201208 Empty Enclosure with No Flap	205	125	80
040-942	Robust 201210 Deep Empty Enclosure with No Flap	205	125	100
040-935	Robust 261810, Empty Enclosure with No Flap	261	181	104
040-962	Robust 282513 Empty Enclosure with No Flap	280	250	130
040-952	Robust 483080 Empty Enclosure with No Flap	476	296	80
040-937	Robust 574310 Empty Enclosure with No Flap	570	430	100

- Weather and UV resistant
- Up to 4 pole din breakers or isolators
- IP Level: 66
- Made from GRP - Glass Reinforced Polyester

Material	SMC (Sheet Moulding Compound)			
Operating Temperature	-50° C to - 200° C			
Glow Wire Capability / Flammability	960° / UL94 V0			
Expected UV Life (Direct Exposure)	25 years +			
IP Level	IP66			
IK Level	IK10			
Security Level	1	2	3	4

Enclosures

Hinges

Locks

Handles

Accessories

Rotary Operating Handles

Insulators

Transformer Equipment

Index

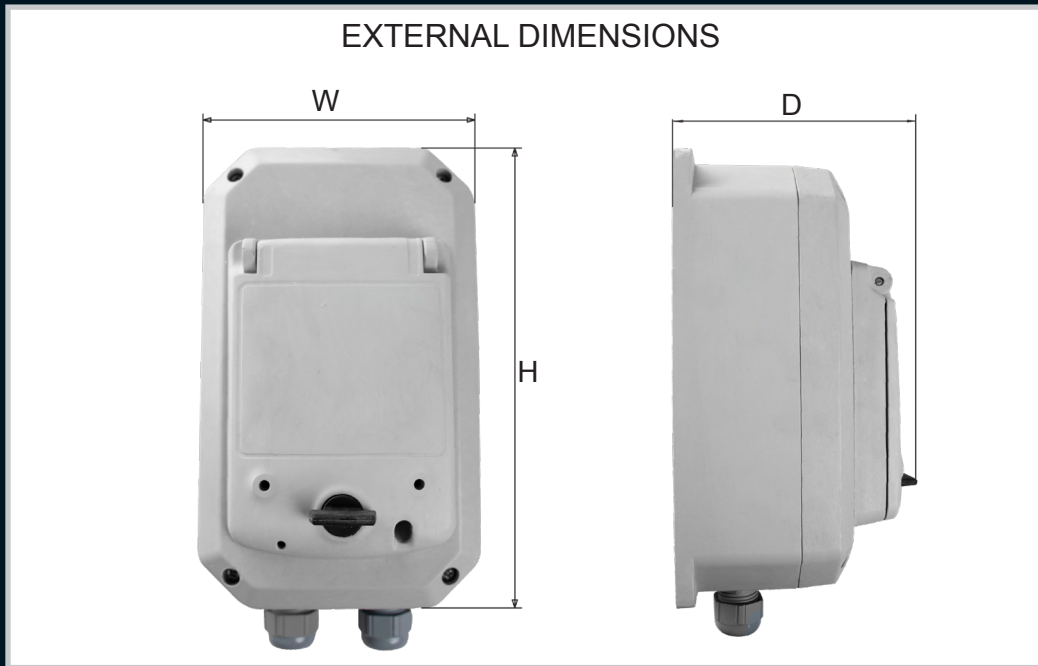

Part Number	Description	H (mm)	W (mm)	D (mm)
040-910	Robust 201208 PC Flap with Barrel Lock	205	125	80
040-911	Robust 201208 PC Flap with Plastic Lock	205	125	80
040-912	Robust 201208 GRP Flap with Barrel Lock	205	125	80
040-913	Robust 201208 GRP Flap with Plastic Lock	205	125	80
040-943	Robust 201208 Deep PC Flap with Barrel Lock	205	125	100
040-944	Robust 201208 Deep PC Flap with Plastic Lock	205	125	100
040-945	Robust 201208 Deep GRP Flap with Barrel Lock	205	125	100
040-946	Robust 201208 Deep GRP Flap with Plastic Lock	205	125	100

- Weather and UV resistant
- Up to 4 pole din breakers or isolators
- IP Level: 66
- Made from GRP - Glass Reinforced Polyester

Enclosures

Material	SMC (Sheet Moulding Compound)			
Operating Temperature	-50° C to - 200° C			
Glow Wire Capability / Flammability	960° / UL94 V0			
Expected UV Life (Direct Exposure)	25 years +			
IP Level	IP66			
IK Level	IK10			
Security Level	1	2	3	4

Hinges

Locks

Handles

Accessories

Rotary Operating Handles

Insulators

Transformer Equipment

Index



Part Number	Description	H (mm)	W (mm)	D (mm)
040-969	Temp DB 2 x 16A Panel Sockets 2 x 16A SGL SKT	476	296	80
040-970	Temp DB 4 x 16A Panel Sockets	476	296	80
040-971	Temp DB 6 x 16A Panel Sockets	476	296	80

* NOTE: Above Temporary Distribution Boards are examples only. Allbro is able to configure customer specific solutions .

Benefits of a Temporary Distribution Board:

- Provides temporary power to Construction & Camp sites
- Rugged and Robust in design
- Replaceable plug sockets
- Domestic & Industrial plug socket options
- High IP rating suitable for Boat docks and Piers
- Single phase 230V AC
- Full 30mA Earth leakage protection.

Notes:

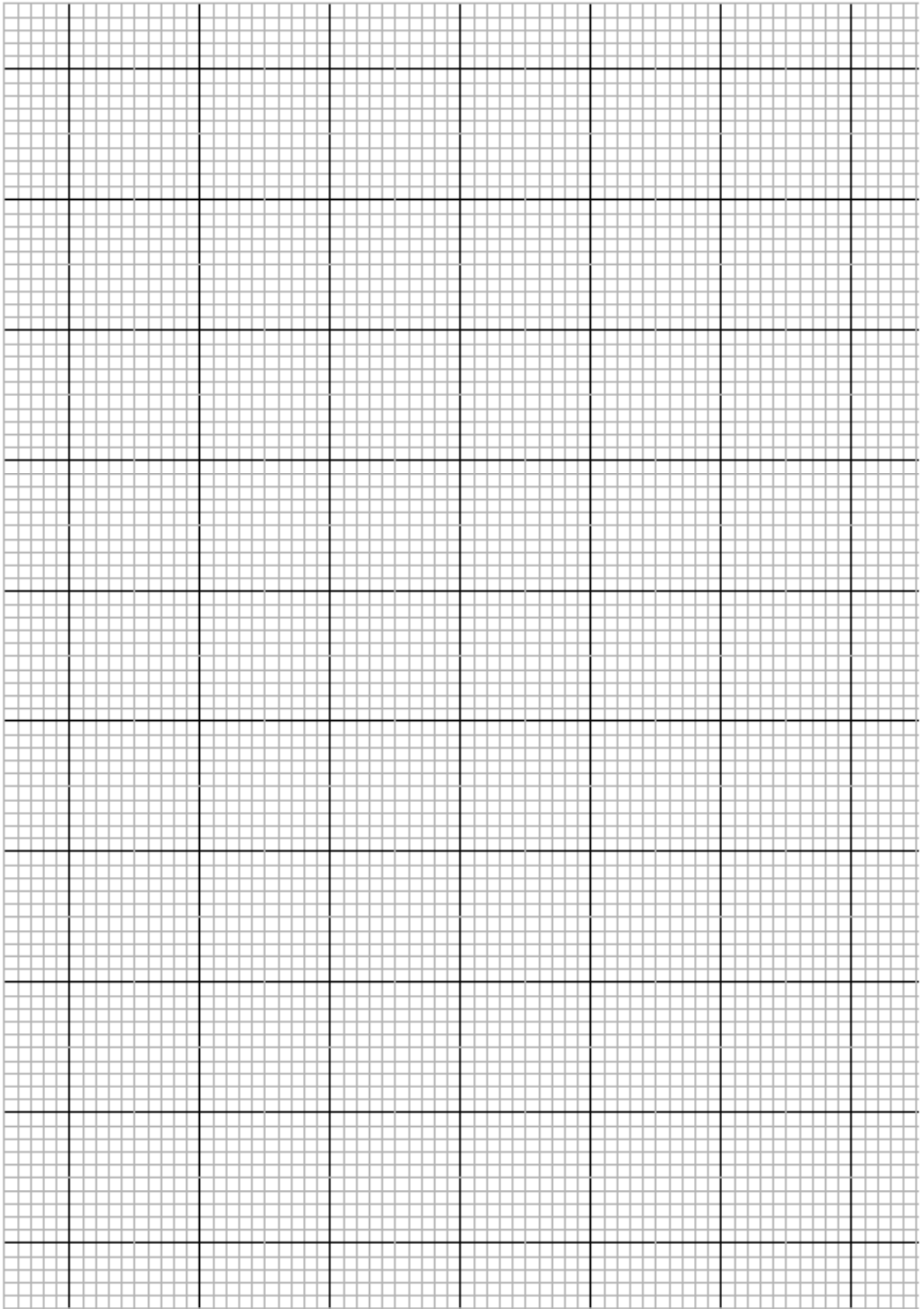

Internal hinges.
(Cannot be compromised from outside)

Intergrated "rain canopy"



Multi-angle mounting brackets



Flame Retardant

IP Level: 66

Flush mounted window option



Quarter Turn Lock

Durable GRP Material

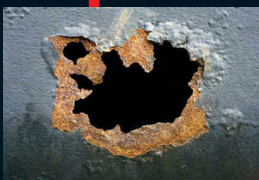

**Can accommodate DB Kit/
Inner Door.**

** Allbrox 4 Deep and 6 Deep can not accommodate DB Kit*



Material	SMC (Sheet Moulding Compound), PC for window			
Operating Temperature	-50° C to + 200° C			
Glow Wire Capability / Flammability	960° / UL94 V0			
Expected UV Life (Direct Exposure)	25 years +			
IP Level	IP66			
IK Level	IK10			
Security Level	1	2	3	4

*** PLEASE NOTE:**

- Allbrox® is not suitable to install on back (Face Up)
- Allbrox® 3-6D must be installed in portrait orientation ONLY.

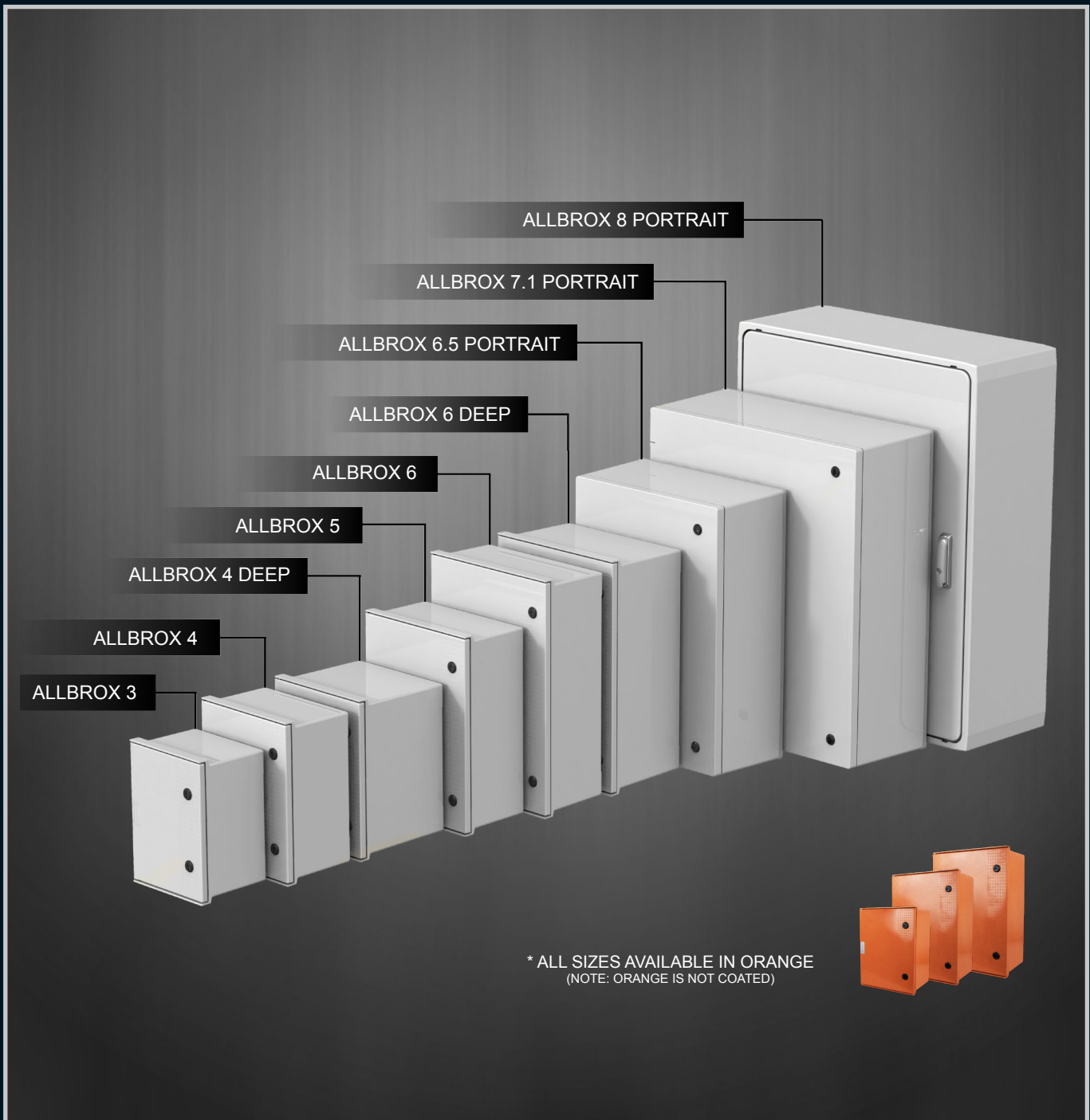

* ALL SIZES AVAILABLE IN ORANGE
(NOTE: ORANGE IS NOT COATED)

Enclosures

Hinges

Locks

Handles

Accessories

Rotary Operating Handles

Insulators

Transformer Equipment

Index

- Enclosures
- Hinges
- Locks
- Handles
- Accessories
- Rotary Operating Handles
- Insulators
- Transformer Equipment
- Index

Material	SMC (Sheet Moulding Compound), PC for window			
Operating Temperature	-50° C to + 200° C			
Glow Wire Capability / Flammability	960° / UL94 V0			
Expected UV Life (Direct Exposure)	25 years +			
IP Level	IP66			
IK Level	IK10			
Security Level	1	2	3	4

*** PLEASE NOTE:**

- Allbrox® is not suitable to install on back (Face Up)
- Allbrox® 3-6D must be installed in portrait orientation ONLY.

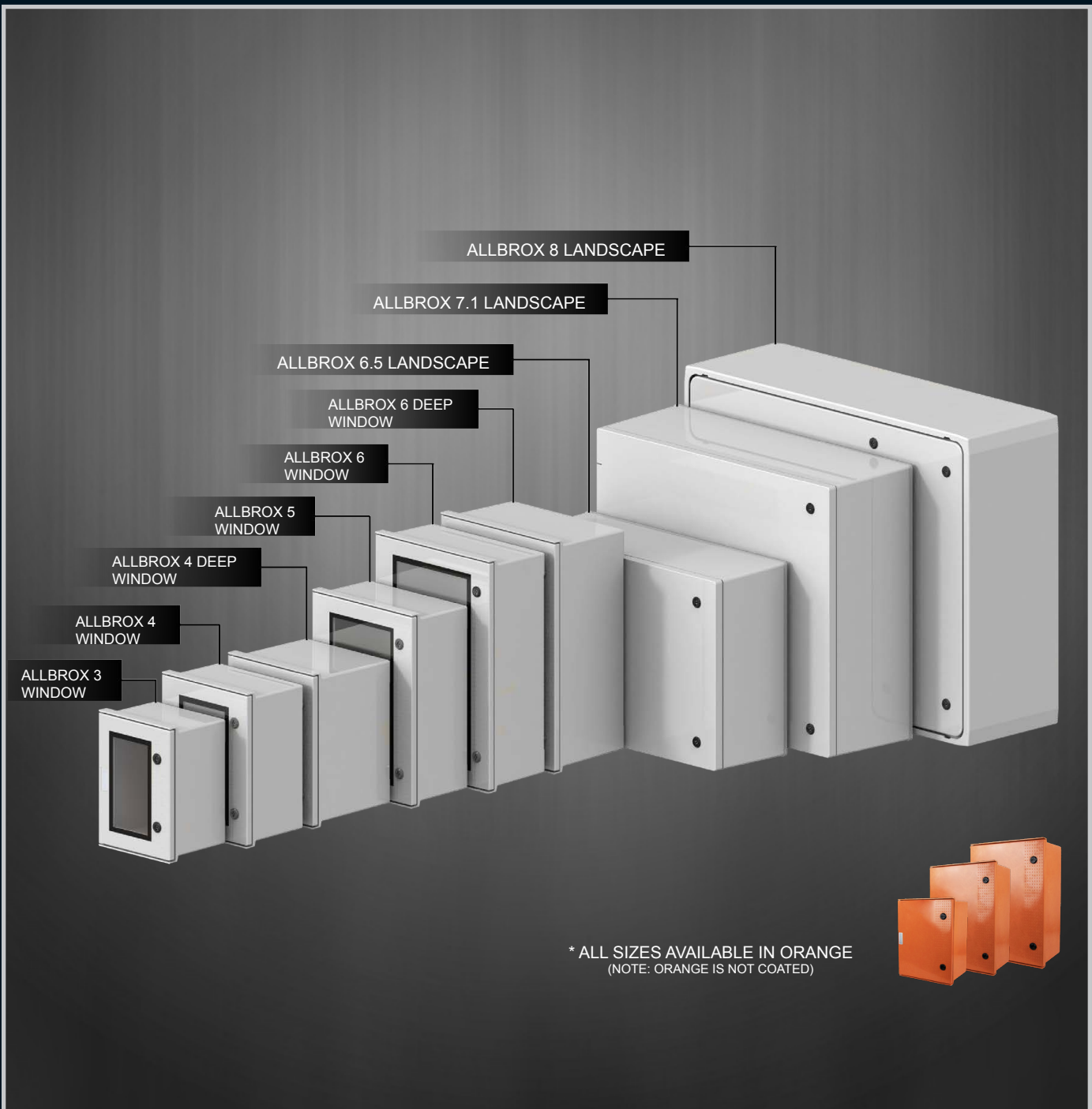

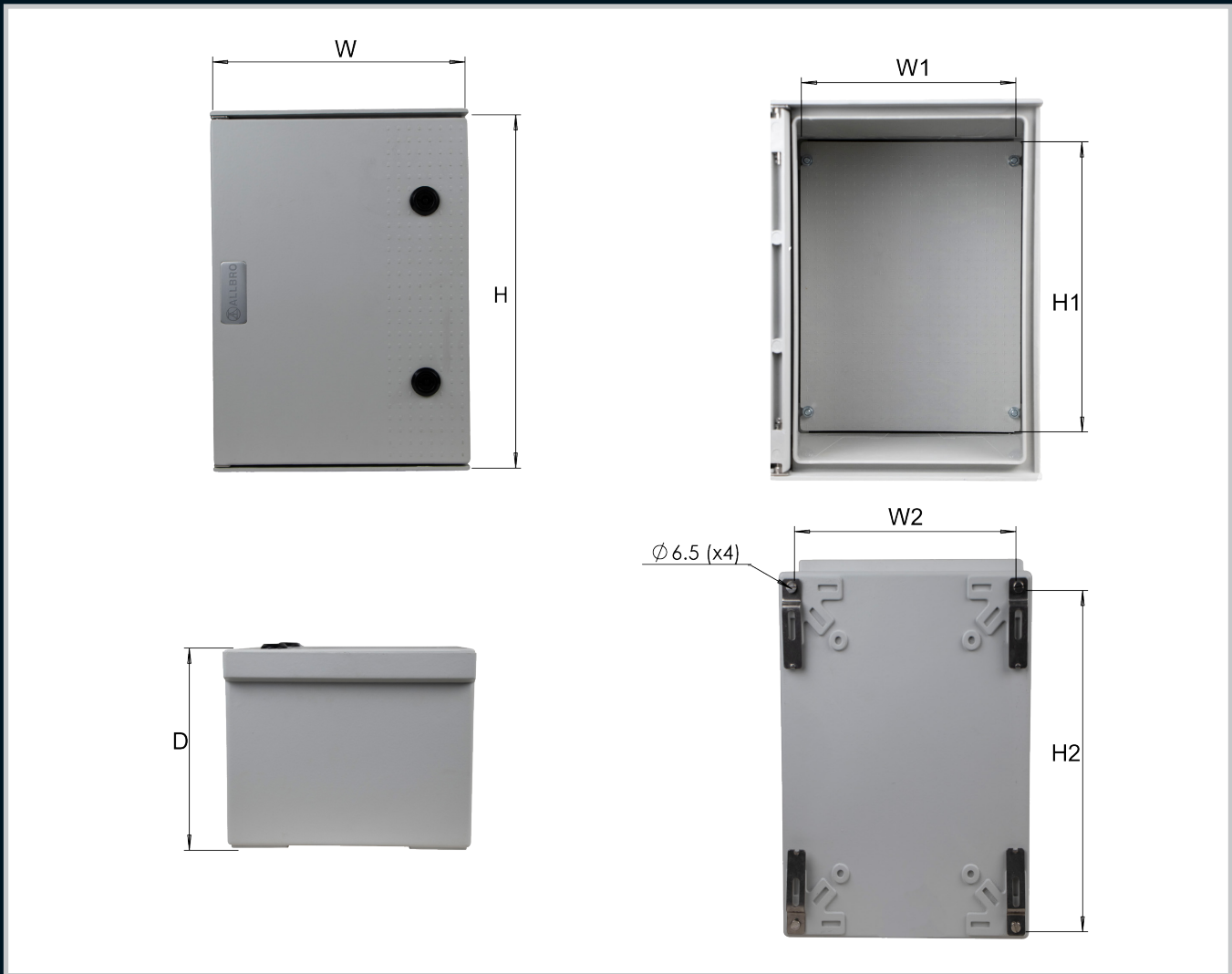

Part Number (Grey)	Part Number (Orange)	Description	H (mm)	W (mm)	D (mm)	W1 (mm)	H1 (mm)	W2 (mm)	H2 (mm)
ALL-003	ALL-003/O	Allbrox 3 with SMC Device plate	350	250	200	212	317	219	292,5
ALL-004	ALL-004/O	Allbrox 4 with SMC Device plate	400	300	200	262	364	269	342,5
ALL-004/D	ALL-004/D/O	Allbrox 4 Deep with SMC Device plate	400	300	273	262	364	269	342,5
ALL-005	ALL-005/O	Allbrox 5 with SMC Device plate	500	350	200	312	467	319	442,5
ALL-006	ALL-006/O	Allbrox 6 with SMC Device plate	600	400	200	362	567	369	542,5
ALL-006/D	ALL-006/D/O	Allbrox 6 Deep with SMC Device plate	600	400	250	362	567	367,3	540,8
ALL-006_5-L	ALL-006_5-L/O	Allbrox 6.5 Landscape with SMC Device plate	500	700	246	619	419	657,9	457,9
ALL-006_5-P	ALL-006_5-P/O	Allbrox 6.5 Portrait with SMC Device plate	700	500	246	419	619	457,9	657,9
ALL-007_1-P	ALL-007_1-P/O	Allbrox 7.1 Portrait with SMC Device plate	828	710	287	634	754	667,4	787,4
ALL-007_1-L	ALL-007_1-L/O	Allbrox 7.1 Landscape with SMC Device plate	710	828	287	754	634	787,4	667,4
ALL-008-P	ALL-008-P/O	Allbrox 8 Portrait with SMC Device plate	1000	800	320	710	910	738/714	914/938
ALL-008-L	ALL-008-L/O	Allbrox 8 Landscape SMC Device plate	800	1000	320	910	710	914/938	738/714

Allbrox Galvanised Steel Device Plate

Part Number	Description	H (mm)	W (mm)	Thickness
ALL-M/SMPLATE-3	ALL Mounting Steel Plate No.3	311	238	1.6
ALL-M/SMPLATE-4	ALL Mounting Steel Plate No.4	361	288	1.6
ALL-M/SMPLATE-5	ALL Mounting Steel Plate No.5	461	338	1.6
ALL-M/SMPLATE-6	ALL Mounting Steel Plate No.6	554	380	1.6
ALL-M/SMPLATE-6_5	ALL Mounting Steel Plate No.6_5	590,7	390,7	2
ALL-M/SMPLATE-7	ALL Mounting Steel Plate No.7	605	532,7	2

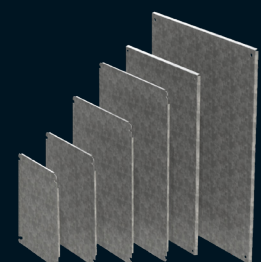

Enclosures

Hinges

Locks

Handles

Accessories

Rotary Operating Handles

Insulators

Transformer Equipment

Index

ALLBROX® 4-6

Distribution Board Kit



Allbrox® Distribution Board Kit

Part Number	Description	No. of Rows	MCB's Per Row	No. of Neutral Bars	No. of Earth Bars
ALL-004/DBK-A	Allbrox 4 Distribution Board Kit Assembled	2	10	2x (14 way)	2x (12 way)
ALL-005/DBK-A	Allbrox 5 Distribution Board Kit Assembled	3	13	4x (14 way)	4x (12 way)
ALL-006/DBK-A	Allbrox 6 Distribution Board Kit Assembled	4	15	5x (15 way)	2x (18 way) + 2x (12 way)

Allbrox® Distribution Board Kit Assembly

1) Remove device plate from the base. Leave the 4 x M6 nuts in place for fixing the mounting rails in place. Fit mounting rails (A) as shown using the 4 x M6 x 12 CH EG screws and M6 washers. Ensure that the bigger space between the hole and end of the mounting rail is fitted toward the hinge side of the box.

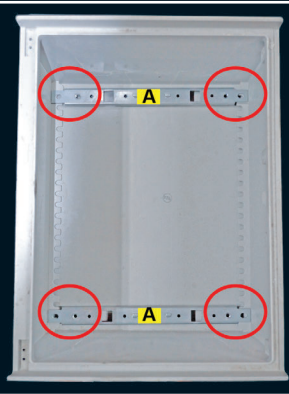

2) Fit the steel side plates with the plastic supports (B) onto the mounting rails (A) using the 4 x M6 x 12CH EG screws and M6 washers as shown.

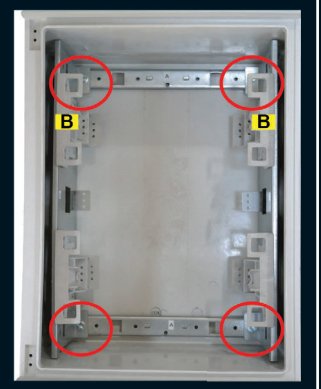

3) Fit the steel din rails (C), for breakers, into the plastic supports using 2 x 3.5 x 12 Panpozi thread cutter screws on each end as shown. Fit the steel din rail, for neutral bar, upside down using 2 x 8 x 9.5 thread cutter screws on each end as shown.

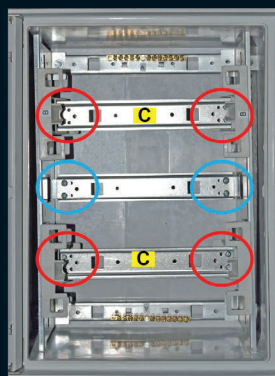

3.5 x 12 Panpozi thread cutter screws

8 x 9.5 Panpozi thread cutter screws

4) Clip the plastic Fascia plates (D) into the plastic supports as shown.

Product	No. Fascia Plates
ALLBROX 4	2
ALLBROX 5	3
ALLBROX 6	4



ALLBROX® 4-6

Inner Doors



Allbrox® Inner Door

Part Number	Description
ALL-004/IN/DOOR	Allbrox 4 Inner Door
ALL-005/IN/DOOR	Allbrox 5 Inner Door
ALL-006/IN/DOOR	Allbrox 6 Inner Door

Allbrox® with PC Window

Part Number	Description
ALL-003/CLEARPC	Allbrox 3 with clear Polycarbonate window
ALL-004/CLEARPC	Allbrox 4 with clear Polycarbonate window
ALL-005/CLEARPC	Allbrox 5 with clear Polycarbonate window
ALL-006/CLEARPC	Allbrox 6 with clear Polycarbonate window

Allbrox® Inner Door Fitting Options

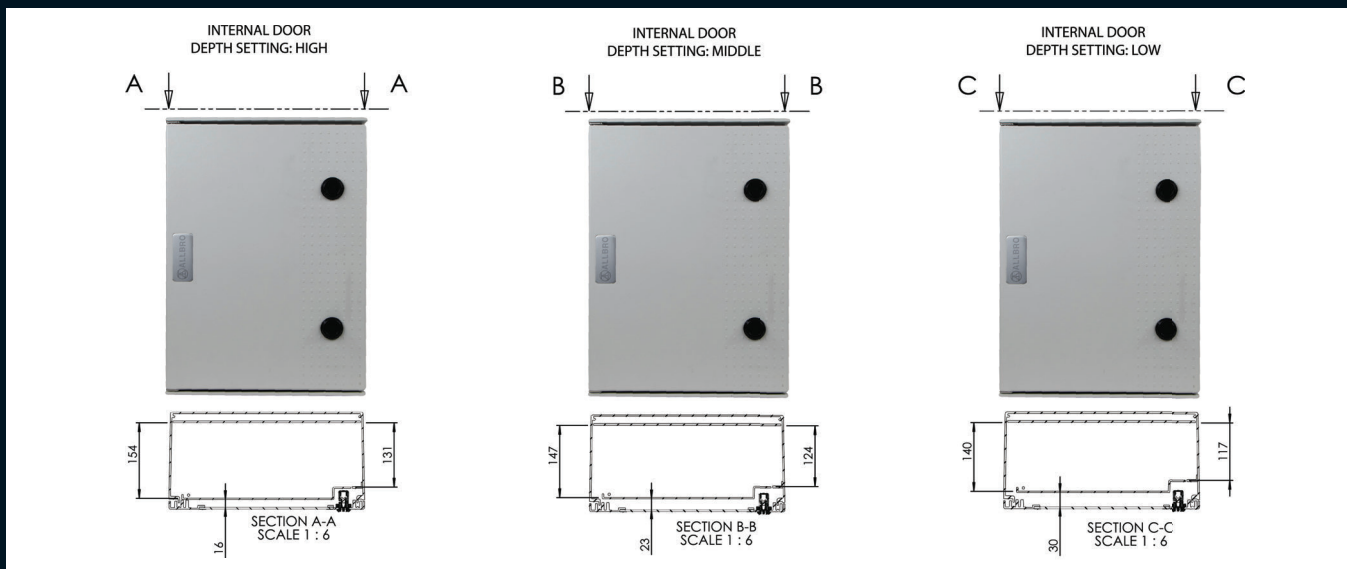

1) To remove or place the inner door in an Allbrox® simply pull the two hinge pins as indicated towards each other.



2.1) To remove the door, complete step 1 and pull the inner door towards yourself.

2.2) To place the inner door into the Allbrox® complete step 1 and let the hinge pins go once the pins are in-line with the hinge sleeve.

Enclosures

Hinges

Locks

Handles

Accessories

Rotary Operating Handles

Insulators

Transformer Equipment

Index

* Please note that the construction of the 6.5 and 7.1 sizes differs from the smaller sizes (3-6D)

Enclosures

ALLBROX® 6.5

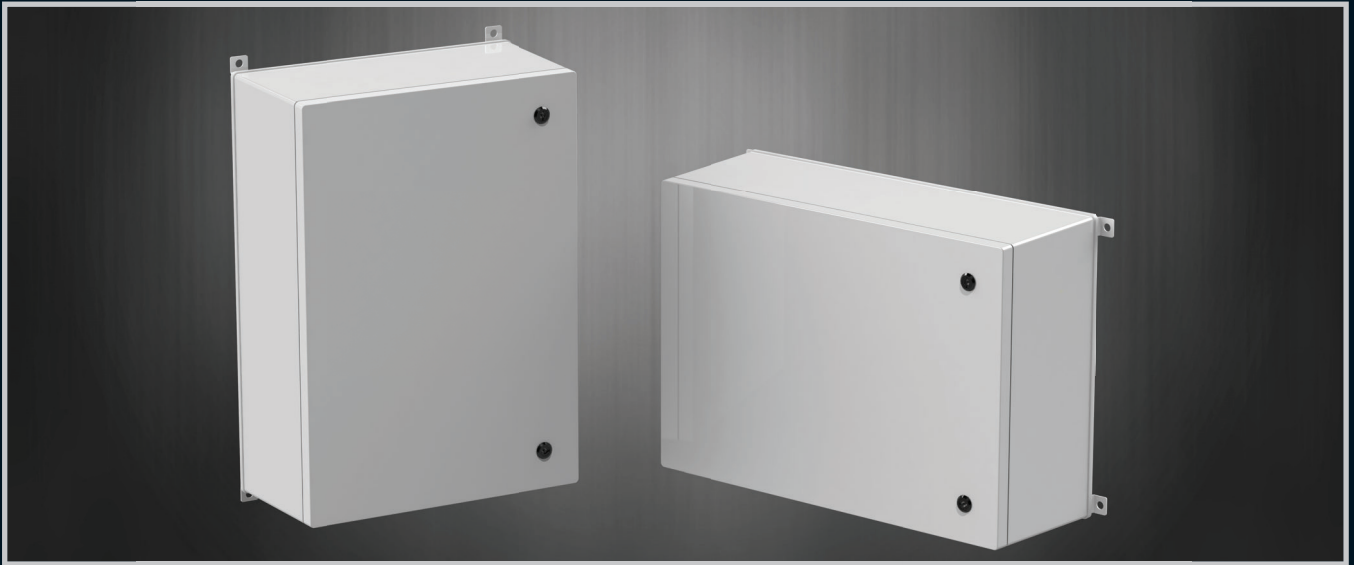

Hinges

Locks

Handles

ALLBROX® 7.1

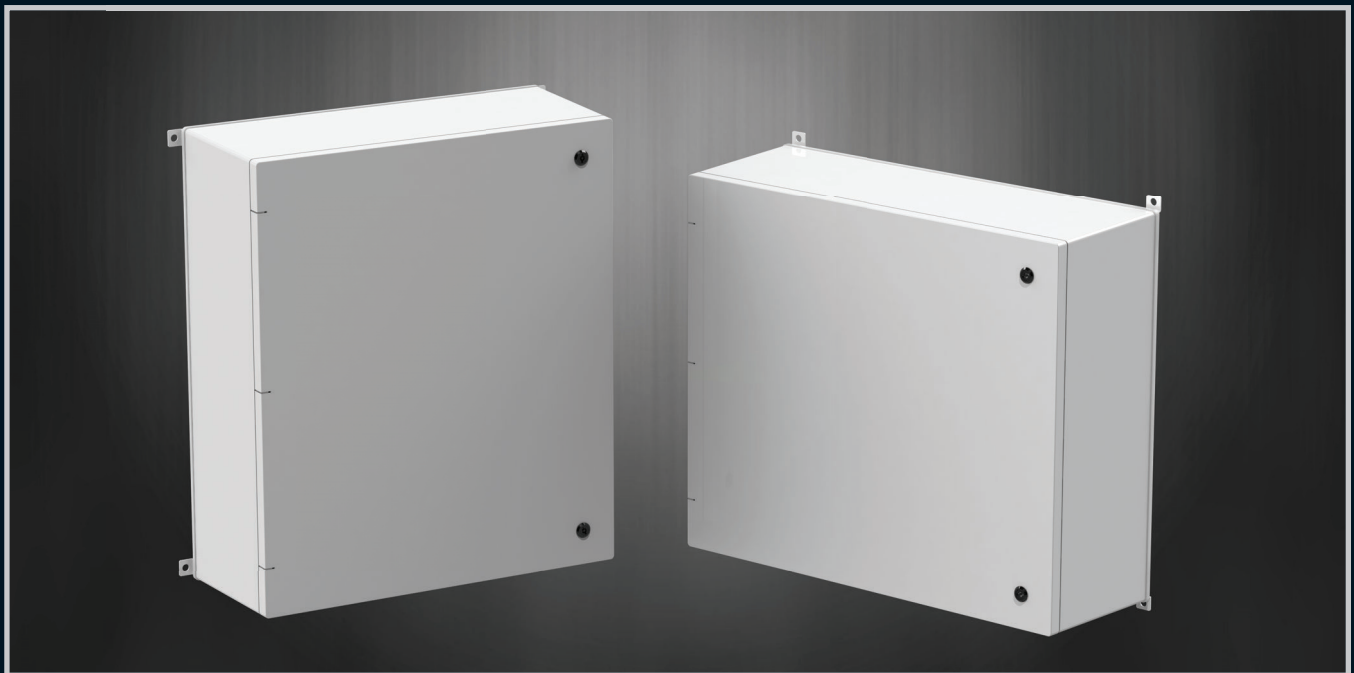

Accessories

Rotary Operating Handles

Insulators

Transformer Equipment

Index

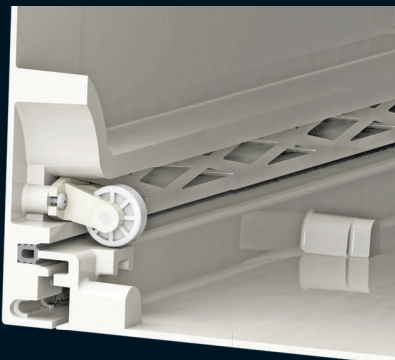

Door locator



Extra strength lid



Easily Removable door



Enclosures
Hinges
Locks
Handles
Accessories
Rotary Operating Handles
Insulators
Transformer Equipment
Index

Enclosures

Hinges

Locks

Handles

Accessories

Rotary Operating Handles

Insulators

Transformer Equipment

Index



- 4 String
- IP66
- GRP (Glass Reinforced Polyester)
- Ideal for residential, commercial and light industrial PV systems

Part Number	Description	H (mm)	W (mm)	D (mm)
040-924	4 String Combiner with Surge Arrester	261	181	104
040-925	4 String Combiner without Surge Arrester	261	181	104

FUSE HOLDER
(Positive and negative poles) for incoming current

- PV fuses
- Fuse rating: 15A
- Finger safe fuse holders

ALLBRO

16mm Outgoing Terminal

WEIDMULLER

SPD
Class I & II Surge arrester for DC generation circuits

CITEL

Robust Enclosure

ALLBRO

16mm Earth Terminal

WEIDMULLER

INPUTS
MC4 Connectors IP66

MULTI CONTACT

Notes:

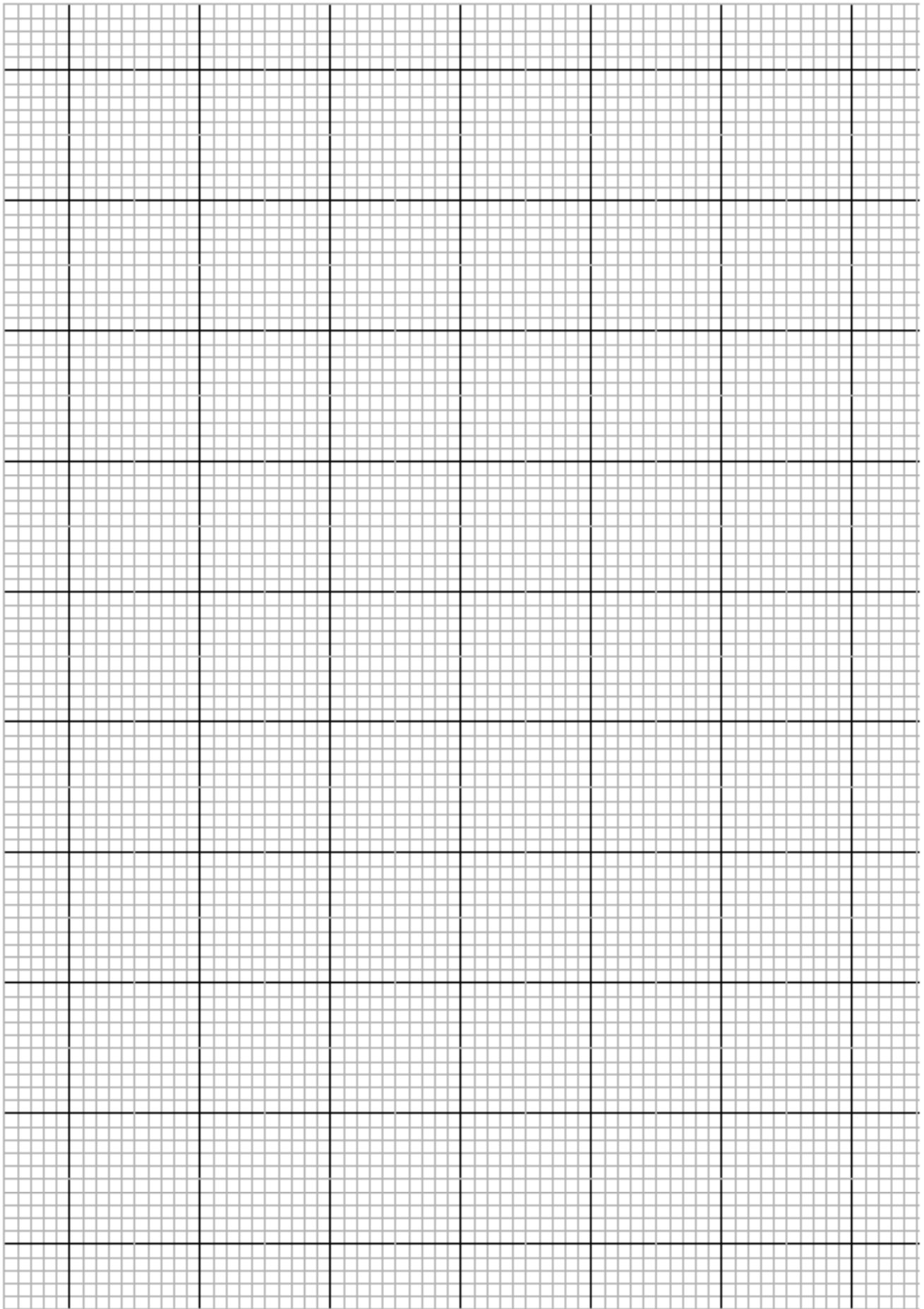

- Enclosures
- Hinges
- Locks
- Handles
- Accessories
- Rotary Operating Handles
- Insulators
- Transformer Equipment
- Index

Optimum seal on lid ensuring zero concrete permeation

Made from GRP (Glass Reinforced Polyester)

***Holesaw Sold Separately**

No pre-defined conduit knock-outs (Conduit hole must be drilled above this line)

Allows for smooth, seamless plastering - No unsightly mesh finishes

Protective cap - Sold Separately

One box achieves multiple down light diameters

The Process:



THE KIT



STEP 1: MARK IT

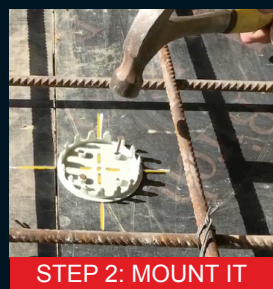

STEP 2: MOUNT IT

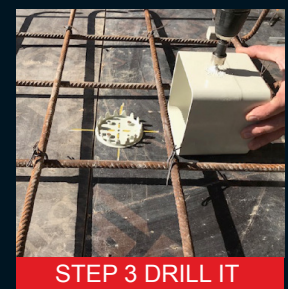

STEP 3 DRILL IT

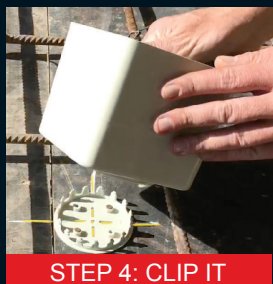

STEP 4: CLIP IT



STEP 5: TIE IT



POUR CONCRETE

Part Number	Description	H (mm)	W (mm)	D(mm)	IP Level
040-941	Slab box complete (PL-01)	140.91	140.91	125	IP66
AE113	Mounting Plate	-	-	-	-
AE114	Protective cap	-	-	-	-

Traditional metal slab boxes currently in use in South Africa pose a varying number of complications when installing. Inconsistent knock outs, poor quality tack welds, difficult alignment process and inconsistent mesh/steel surfaces that can be difficult to plaster.

ALLBRO's new Slab Box™ solves these challenges whilst still offering the benefits of a GRP electrical enclosure. It will offer a single box with three diameters options, no predefined knock-outs, simplified alignment, easy and tidy plastering.

- Metal boxes require separate specific cut outs to cater for the 64mm, 75mm & 85mm down lights generally used. With Slab Box™, you will be able to achieve these diameters with a single box just by using an appropriately sized hole saw (sold separately).



Multiple metal cut-outs



Single cap achieves 85mm , 75mm and 64mm



Various & inconsistent knock-outs



Custom conduit holes for perfect fit

- Predefined metal knock outs sometimes pose a unique challenge due to its poor quality and inconsistent gapping. This could allow concrete to seep into the box during the curing process.

- Perfect alignment of downlights also proves difficult to achieve. Slab Box™ unique yet simple shutter mounting system promises accurate and consistent positioning.



Large cut-outs prove challenging to align



Shutter mount is simple to measure & mark for consistent alignment

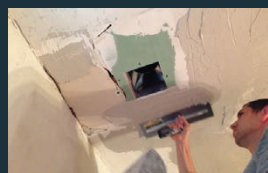

Metal boxes require extra plastering to cover mesh pattern

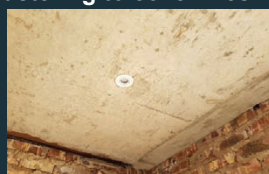
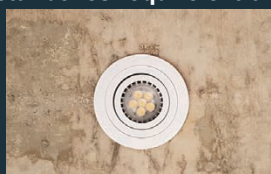

Slab box™ achieves perfect finish. Much less plaster can be used.

- The traditional metal box requires a mesh grid to be welded onto edges to ensure adhesion of plaster. Slab Box™ unique design addresses this ascetic issue of unappealing "grid" surface finishes by eliminating the need to plaster directly onto the box.

Enclosures

Hinges

Locks

Handles

Accessories

Rotary Operating Handles

Insulators

Transformer Equipment

Index

Enclosures

The concept of ready boards was introduced in the mid 90's as a rapid way to deploy basic electrical access to a large portion of the community who were without this commodity. Allbro (York) was the first company in South Africa to create a technically sound commercially viable and large scale production for this concept. Allbro remains one of the largest producers of this product while actively working on creating more sophisticated and sustainable distribution methods for basic electrical supply to the community.

Hinges

2 Platforms

RB - A

NEW-GEN™

Locks

Handles

Accessories



NOTE: The RBH platform has been discontinued. New Gen is a completely new concept and is not directly compatible with the accessories in this section. Please refer to page 74

Available in different Bulkhead options (or no Bulkhead - No Light switch)

Standard Bulkhead

Slimline Bulkhead

CFL only Bulkhead - will not close with standard globes, forcing the consumer to use Low power CFL's

Rotary Operating Handles

Insulators

Transformer Equipment



Index

Part Number	Description	IP
BUL-60W	60watt Bulkhead Ventilated	3X
BUL-100W	100watt Bulkhead Ventilated	3X

Part Number	Description
BUL-SLIMLINE	Slimline Bulkhead

Part Number	Description	IP
LWB-001	CFL Bulkhead	54

Note: We invented these light fittings specifically for our ready boards but many markets now use them as stand alone light fittings.

Different Plugsets



SA Standard

13A Square Pin

Shucko



SA Euro Socket

Different Mounting Options for Easy Deployment

Compact SMC Backing Board

Large SMC Backing Board with Wiring Tunnel



Rails

Rails with Perspex Meter Mounting Point



Enclosures

Hinges

Locks

Handles

Accessories

Rotary Operating Handles

Insulators

Transformer Equipment

Index

- Enclosures
- Hinges
- Locks
- Handles
- Accessories
- Rotary Operating Handles
- Insulators
- Transformer Equipment
- Index

Different Breaker Options

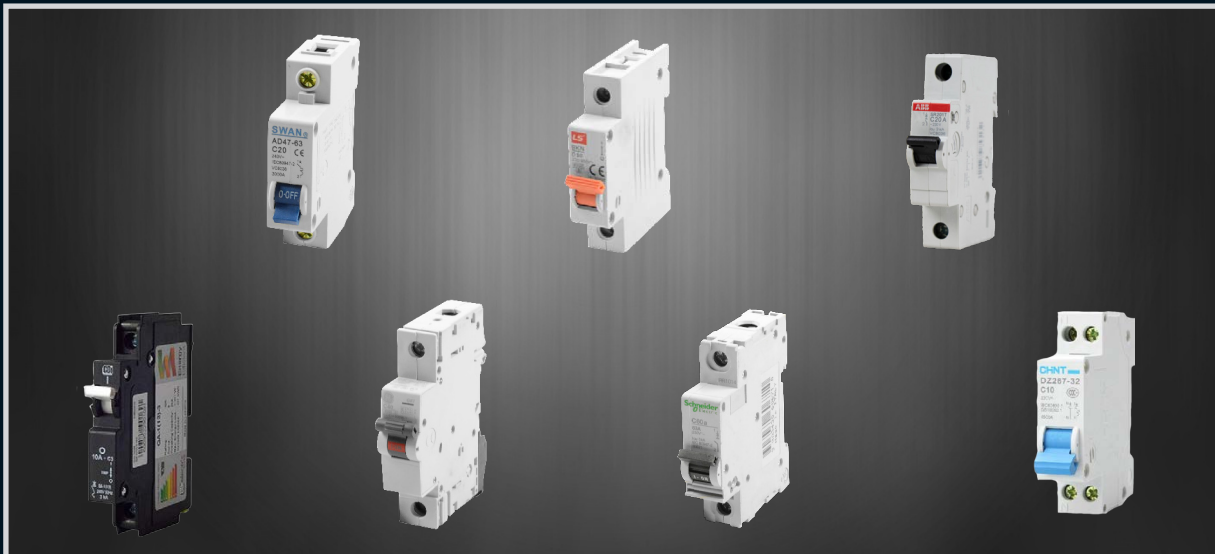

Swan

LS

ABB

CBI

GE

Schneider

Chint

Some PRE - configured Options

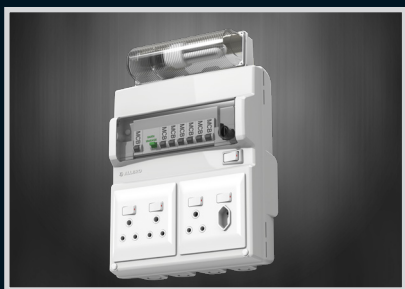

Part Number	Earth Leakage	MCB'S	No of 3 Pin Switched Socket Outlets	Bulkhead Light Fitting with Switch
RBNGC00ZF0E22	63A	2 X 20A	3	1
RBNG000ZF0E22	63A	2 X 20A	3	-



Part Number	Breakers	Earth Leakage	MCB'S	No of 3 Pin Switched Socket Outlets	Bulkhead Light Fitting with Switch
RBA000ZF0E22	Schneider	63A	2 x 20A	3	-
RBAB00ZF0E22	Schneider	63A	2 x 20A	3	1
RBA000ZT0E22	Chint	63A	2 x 20A	3	-
RBAB00ZT0E22	Chint	63A	2 x 20A	3	1

Split meter Ready Board



Part Number	Earth Leakage	MCB'S	No of 3 Pin Switched Socket Outlets	Bulkhead Light Fitting with Switch
040-706	63A	1 x 20A	2	-

Universal Base for Pre- payment meters

Passive With Rails & Plugset



Part Number	Description	Qty per box
PAS	Passive Base with Rails and Plugset	1

Passive With Rails

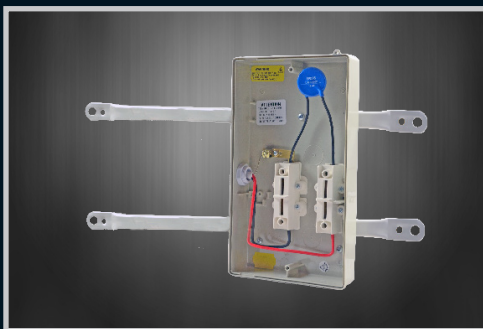

Part Number	Description	Qty per box
PAS-1	Passive Base with Rails	1

Passive



Part Number	Description	Qty per box
PAS-2	Passive Base with Glands and Hole cover	1
PAS -3	Passive base with No Rails, No Glands, No Hole cover	1

Enclosures

Hinges

Locks

Handles

Accessories

Rotary Operating Handles

Insulators

Transformer Equipment

Index

RB Ready Board	Configuration	Bulkhead	Globe	Mounting	Plug Type	Breaker Type	Main Switch/Iso	Earth Leakage/Main	
	A Vertical 	0 No Bulkhead	0 None	0 None	Z SA type 	S Swan 	0 None	E 63EL 63A DP EL Isol 	0 None
	NG New Gen 	B Standard Bulkhead 	G Globe 14w CFL 	L Large SMC backing board 	S Shuko type 	A ABB 	1 1 x 25A MCB	C GL breaker combination 	1 1 x 10A SP MCB
		C CFL-Round 	L LED Lamp 	S Small SMC backing board 	B BS type 	L LS 	2 1 x 10A MCB	L 40A EL 	2 1 x 20A SP MCB
		S Slimline 		R Rails 	E Euro type 	G GE 	3 1 x 16A 2P MCB		3 1 x 32A SP MCB
		X 5m Lead with Lampshade 		P Rails with perspex mounting 	Note: New Gen has an additional 3 way - 2 pin socket configuration 	C CBI / Din 	4 1 x 40A MCB		4 1 x 6A SP MCB
		M 3m lead with Bulkhead 		E Rails with Passive 		B CBI / Sam 	5 1 x 50A MCB		5 1 x 63A SP MCB
		N 2m lead with Bulkhead 		M Mounting Plate 		F Schneider 	6 1 x 63A MCB		6 1 x 16A SP MCB
				G Rails with 4x4 plugset 		T Chint 	7 1 x 32A MCB		7 1 x 25A SP MCB
						E Lesco 			
						0 None 			

Note:

Please note that number indicates position & current rating of breaker.

Example:

(22) = 2 x 20A
(212) = 1 x 20A, 1 x 10A, 1 x 20A

How the coding system works

Example:

You are looking for the following requirements in your Ready Board:

- Vertical configuration
- Standard Bulkhead
- With a Globe
- Large mounting plate
- SA type plug
- Swan breakers
- No main switch
- Earth Leakage
- 2 x 20A SP MCB
- 1 x 16A SP MCB
- 1 x 32A SP MCB

Your code is then created using the table on the previous page and looks like this:

RBABGLZS0E2263

* Should you need any assistance please contact our sales department.

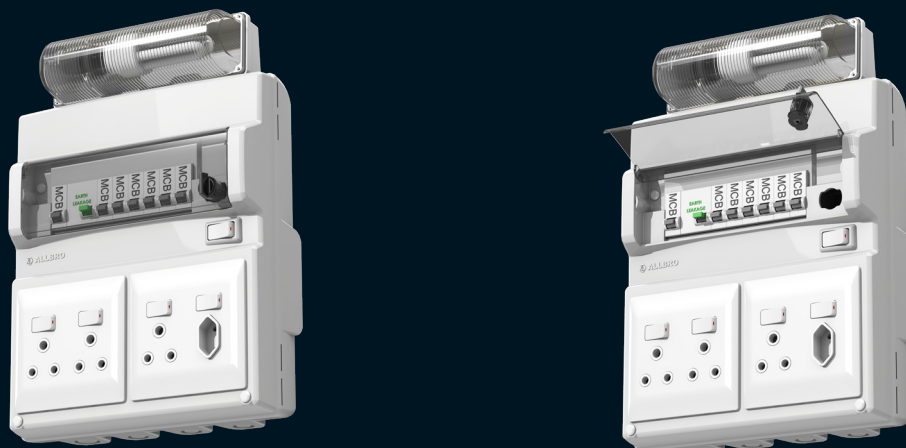

Enclosures

Hinges

Locks

Handles

Accessories

Rotary Operating
Handles

Insulators

Transformer
Equipment

Index

Enclosures

The New Gen ready board System is a world first expandable ready board system. The New Gen ready board comes paired with a CFL bulkhead and is fitted with an LED globe. The key feature that makes this ready board system unique is the “room extender” can be attached using a daisy chain method throughout various rooms in the house giving access to multiple plug points as well as a light. The room extenders are available in different cord lengths: 2.7m, 6.7m and 10.7m to ensure that there is enough cord for installation in different applications. The device plate at the back of the room extender makes installation easy & efficient as it can be done without the use of an electrician.

Hinges

Locks

Handles

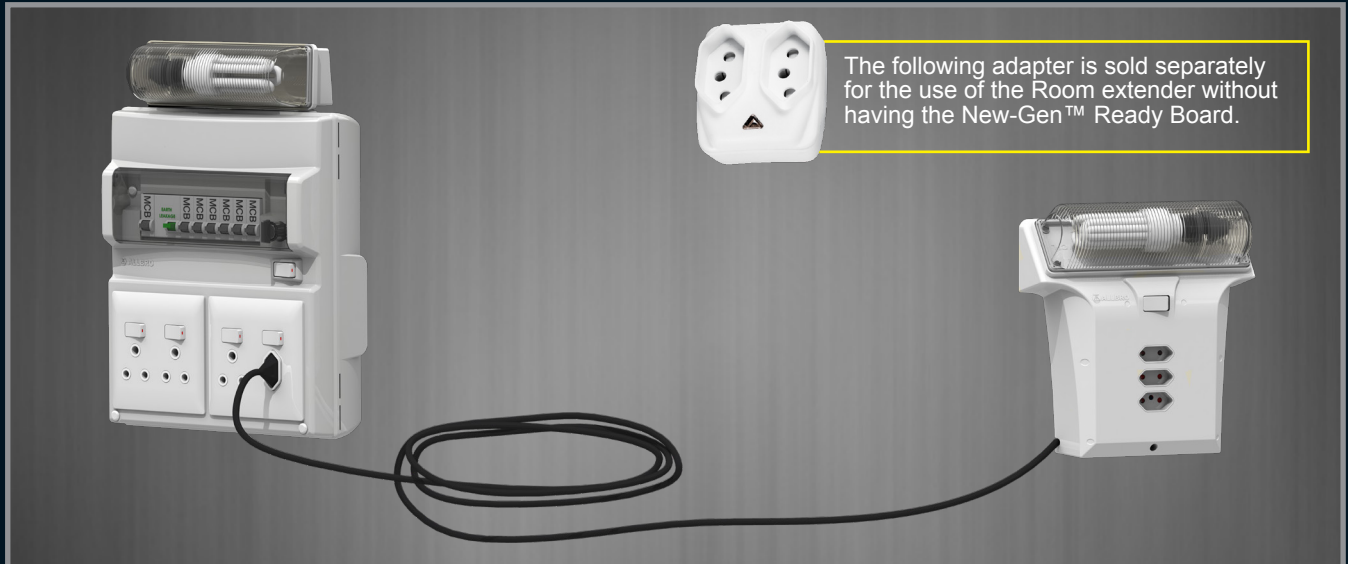

Accessories

Part Number	Description	H (mm)	W (mm)	D(mm)	Cable Length
040-959	Room Extender Complete	257	240	83	2.7m
040-960	Room Extender Complete	257	240	83	6.7m
040-961	Room Extender Complete	257	240	83	10.7m
P/S060	Plug in Adaptor 2 x 16A / 6A Slimline	53	50	38	-

PLEASE NOTE:

- The combined length of cables assembled in any chain should not exceed 25m.
- The circuit should be connected to a Distribution board with a 16A circuit breaker.

Rotary Operating Handles

Room Extender Mounting System

Insulators

Transformer Equipment

Index

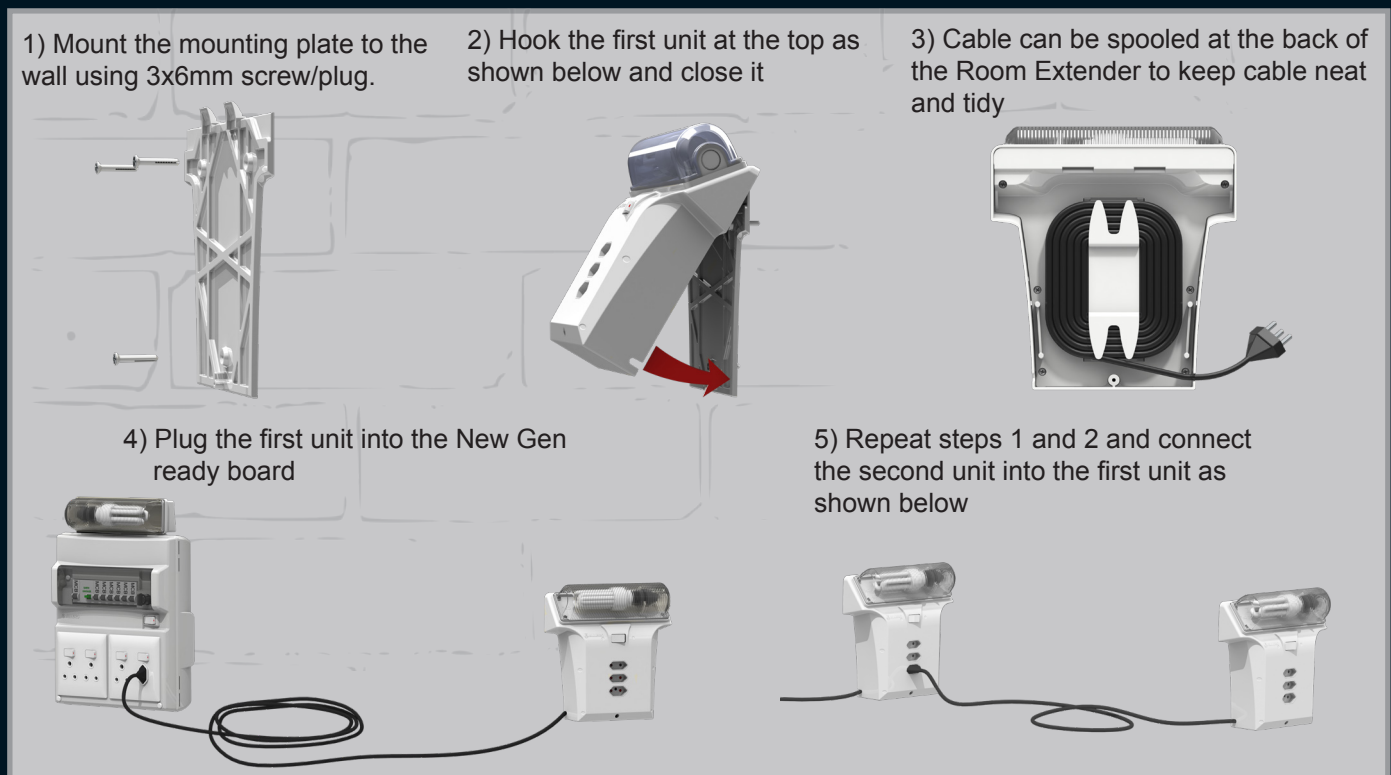



Part Number	Description	H (mm)	W (mm)	D (mm)	Qty per box
040-609	PSO-1 (S15)	85	130	70	24
040-662	PSO-1/A with single socket outlet	85	130	70	24



Part Number	Description	H (mm)	W (mm)	D (mm)	Qty per box
040-609/ISO	PSO-1/ ISO with 60 Amp Isolator	85	130	70	24



Part Number	Description	H (mm)	W (mm)	D (mm)	Qty per box
040-754	S15- Duo Empty Double socket outlet	130	130	70	12
040-770	S15/A- Duo with Double socket outlet	130	130	70	12



Part Number	Description	H (mm)	W (mm)	D (mm)	Qty per box
040-610	PSO-2 (F010)	130	173	88	12
040-663	PSO-2/A with double socket outlet	130	173	88	12

Enclosures

Hinges

Locks

Handles

Accessories

Rotary Operating Handles

Insulators

Transformer Equipment

Index

PSO-1 Stealth

Weatherproof socket outlet box



Enclosures

Material	DMC (Dough Moulding Compound)
Operating Temperature	-50°C to + 200° C
Glow Wire Capability / Flammability	960° / UL94 V0
Expected UV Life (Direct Exposure)	GRP Flap 25 years + , Plastic Flap 3 - 5 years exposed
IP Level	IP66 without cable & IP54 with cable
Security Level	Level 1 without pad-lock and Level 3 with pad-lock

Hinges

Locks

Handles

Accessories

Rotary Operating Handles

Insulators

Transformer Equipment

Index



Surface Mounted

Flush Mounted

Flush Mounted

Surface Mounted

Part Number	Description	H (mm)	W (mm)	D (mm)
040-607	PSO-1 Stealth with GRP flap	176	132	94
040-608	PSO-1 Stealth with PC flap	176	132	94

Note:

- Plastic flap is not suitable for areas with direct sunlight.
- PSO-1 Stealth comes fitted with an Allbro socket.

- **Flush/Surface Mounted**
- **Easy & Simple to install**
- **Available with Plastic/GRP flap**
- **Pad-lockable**



Pad-lockable

PSO-Stealth fits pad-lock size 262,
*Size may vary according to make.

Installation:

Flush Mounted:

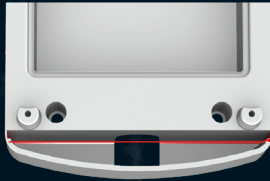

Cut the PSO-1 Stealth on the provided cut lines



Cut the PSO-2 Stealth on the provided cut lines

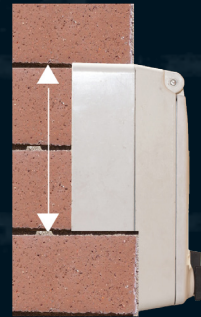

Once optional cut-section is removed, PSO-1 Stealth / PSO-2 Stealth fits between two bricks making installation simple and easy.

Surface Mounted:

***NO CUTTING REQUIRED FOR SURFACE MOUNTING**



Place the PSO-1 Stealth/ PSO-2 Stealth in the desired area and fix on wall using 6mm Nail in anchor screws. This modern weatherproof plug box leaves you with a modern finish PLUS all the benefits of the original plug box you know and have trusted for 40 years

Note: South Africa's new plug and socket standard, SANS 164-2 or ZA Plug, has become mandatory for new installations. This means that any new buildings erected must incorporate electrical sockets that conform to the new standard .

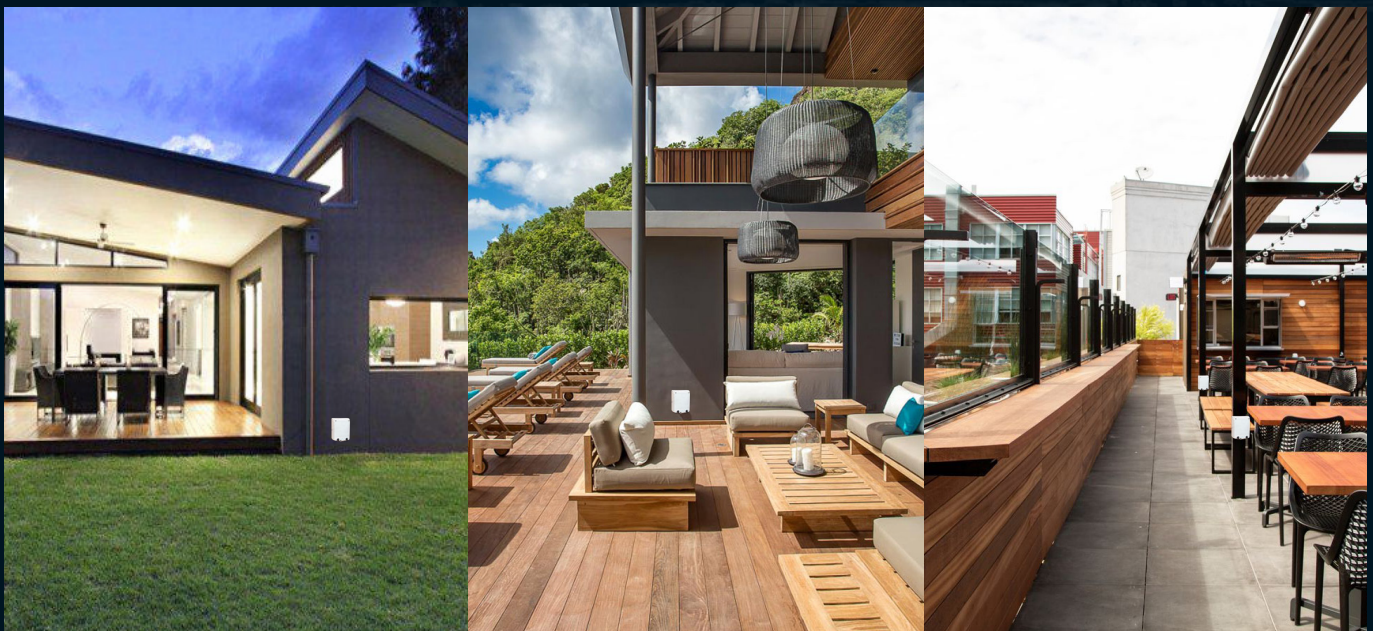

Enclosures

Hinges

Locks

Handles

Accessories

Rotary Operating Handles

Insulators

Transformer Equipment

Index

PSO-2 Stealth

Weatherproof socket outlet box



Enclosures

Material	DMC (Dough Moulding Compound)
Operating Temperature	-50° C to + 200° C
Glow Wire Capability / Flammability	960° / UL94 V0
Expected UV Life (Direct Exposure)	GRP Flap 25 years + , Plastic Flap 3 - 5 years exposed
IP Level	IP66 with/without cable
Security Level	Level 1 without pad-lock and Level 3 with pad-lock

Hinges

Locks

Handles

Accessories



Rotary Operating Handles

Part Number	Description	H (mm)	W (mm)	D (mm)
040-955	PSO-2 Stealth GRP Window	208,5	167	107,5
040-954	PSO-2 Stealth PC Window	208,5	167	107,5

Note:
Plastic flap is not suitable for areas with direct sunlight.
PSO-2 Stealth is supplied without socket.

Insulators

The PSO-2 Stealth is the latest edition to the PSO-Stealth family. The PSO-2 Stealth has all the features and benefits of the PSO-1 Stealth with the addition key features that makes this weatherproof socket outlet box a must have!

The additional features of PSO-2 Stealth:

- PSO-2 Stealth can be fitted with most 4x4 sockets in the market.
- PSO-2 Stealth is IP66 with cable.

Transformer Equipment

- Fully Waterproof (IP66)
- Flush/Surface Mounted
- Easy & Simple to install (See pg.77)
- Available with Plastic/GRP flap
- Pad-lockable

Index

Pad-lockable
PSO-Stealth fits pad-lock size 262,
*Size may vary according to make.

Material	DMC (Dough Moulding Compound)
Operating Temperature	-50° C to + 200° C
Glow Wire Capability / Flammability	960° / UL94 V0
Expected UV Life (Direct Exposure)	GRP Flap 25 years + , Plastic Flap 3 - 5 years exposed
IP Level	IP66
Security Level	Level 1 without pad-lock and Level 3 with pad-lock



Part Number	Description	H (mm)	W (mm)	D (mm)
040-972	Stealth ISO with GRP Flap	176	132	94
040-973	Stealth ISO with PC Flap	176	132	94

- Fully Waterproof (IP66)
- Flush/Surface Mounted
- Available with Plastic/GRP flap
- Pad-lockable

Information on Isolator Switch:

- **Product Rating:** 30A, 250V AC
- **Product Description:** 30A double pole isolator (100mm x100 mm)
- **Conductive Material:** Copper with silver tip contact



Enclosures

Hinges

Locks

Handles

Accessories

Rotary Operating Handles

Insulators

Transformer Equipment

Index

Enclosures

Fitted Pool Boxes



Part Number	Description	H (mm)	W (mm)	D (mm)	Qty per box	
040-659	WP-1 with 125VA & Dial Timer	315	185	120	4	Pool-Fit
040-660	WP-1 with 125VA & Panasonic Timer	315	185	120	4	Pool-Fit
040-683	WP-1 with 300VA & Dial Timer	315	185	120	4	Pool-Fit
040-684	WP-1 with 300VA & Panasonic Timer	315	185	120	4	Pool-Fit

Hinges

Empty Pool Boxes



Part Number	Description	H (mm)	W (mm)	D (mm)	Qty per box	
040-617	WP-1DIN E+N Bar	315	185	120	6	Pool -DIN
040-667	WP-1SAM E+N Bar	315	185	120	6	Pool - SAM
040-668	WP-1 DIN+Wooden block	315	185	120	6	Pool- 5way DIN
040-669	WP-1 SAM+Wooden block	315	185	120	6	Pool- 6way SAM
040-689	WP-1 Din + Raised wooden block	315	185	120	6	Pool-DIN wood

Locks

Handles

Accessories



“Stand up” Pool Box

Part Number	Description	H (mm)	W (mm)	D (mm)	Qty per box
040-953	Standup Pool Box with 125VA transformer	290	280	169	1
040-957	Standup Pool Box without transformer	290	280	169	1

Rotary Operating Handles

Insulators

Transformer Equipment

Index





A challenge that every pool owner is familiar with is the setting of the pool timer. While the complexity of the timer device is well within the grasp of a technology savvy populace, the difficulty in making eye contact with the timer is the main challenge. Allbro has solved this problem with the “Stand Up” Pool Box™.

ADDITIONAL INFORMATION

IP Rating:	IP66 - With all access windows closed
Glow Wire Capability:	960°
Flammability:	UL94 V0
Maximum Current Rating:	32 Amps
Supply Voltage:	220 - 230V AC Single Phase
Rail Type:	Din Rail
Transformer Rating:	223 - 12V AC, 125VA 50Hz, Class II Isolating Transformer complying to SANS 61558-2-6

Features of the “Stand Up” Pool Box™:

- Timer is located at the top of the Pool Box
- See through breaker and timer access windows
- Separate access points for resetting of breakers and setting timer
- Individually pad-lockable access windows for controlled access
- Top orientated timer for ease of adjustment
- Pre-wired to terminal block for ease of wiring
- Moulded wall mounting brackets

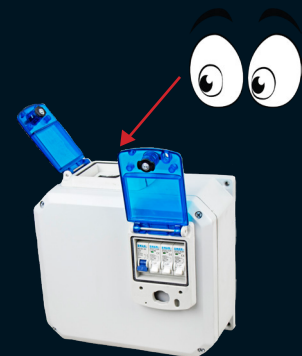

“Stand Up” Pool Box™ without transformer
(Transformer is only required for pool lights)

“Stand Up” Pool Box™ with transformer



- 4 Way Access Windows
- 1x Digital Timer - DHC20A
- 1x 32A Double pole isolator
- 1x 16A Single Pole MCB
- 1x 10A Single Pole MCB

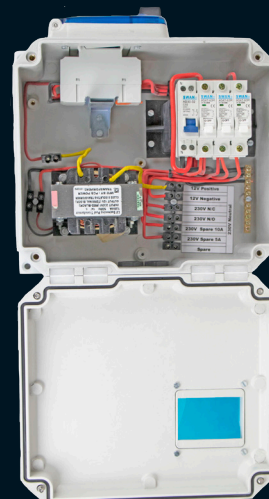

- 4 Way Access Windows
- 1x Digital Timer - DHC20A
- 1x 125VA Transformer
- 1x 32A Double pole isolator
- 1x 16A Single Pole MCB
- 1x 10A Single Pole MCB

*Smaller transformer available on request.

Enclosures

Hinges

Locks

Handles

Accessories

Rotary Operating Handles

Insulators

Transformer Equipment

Index

Enclosures

Material	DMC (Dough Moulding Compound)
Operating Temperature	-50° C to + 200° C
Glow Wire Capability / Flammability	960° / UL94 V0
Expected UV Life (Direct Exposure)	GRP Flap 25 years + , Plastic Flap
IP Level	IP66
Security Level	Level 1 without pad-lock and Level 3 with pad-lock

Hinges

Locks

Handles



Accessories

Rotary Operating Handles

Insulators

Transformer Equipment

Index

Part Number	Description	H (mm)	W (mm)	D (mm)
040-965	8 Way Surface Din ADB GRP Flap	216	266	111
040-980	8 Way Surface Din ADB Plastic Flap	216	266	111
040-981	8 Way Flush Din ADB GRP Flap	216	266	111
040-968	8 Way Flush Din ADB Plastic Flap	216	266	111
040-982	8 Way Surface Samite ADB GRP Flap	216	266	111
040-984	8 Way Surface Samite ADB Plastic Flap	216	266	111
040-983	8 Way Flush Samite ADB GRP Flap	216	266	111
040-985	8 Way Flush Samite ADB Plastic Flap	216	266	111



Pad-lockable
 ADB- Distribution Boards fits pad-lock size 262,
 *Size may vary according to make.

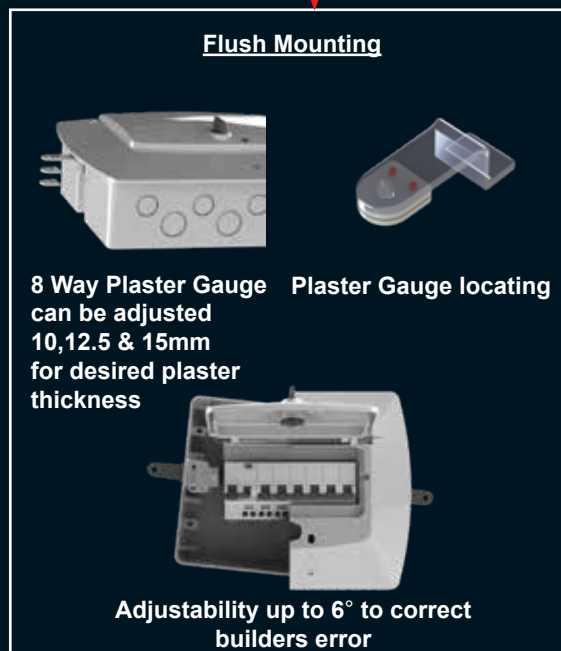
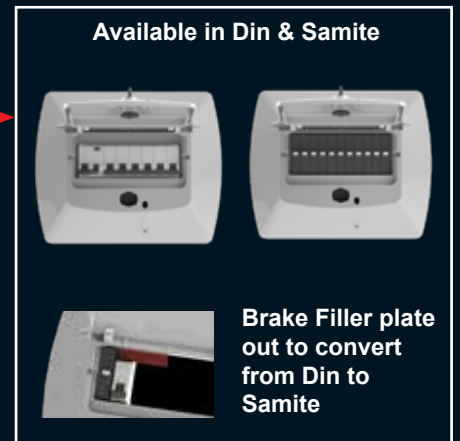

Enclosures

Hinges

Locks

Handles

Accessories

Rotary Operating
Handles

Insulators

Transformer
Equipment

Index

SMART GRIDS

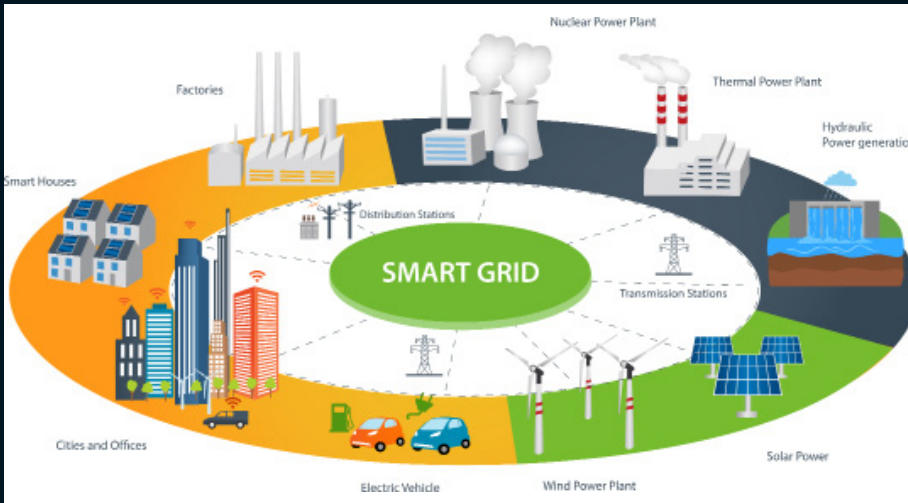

MICRO/MINI GRIDS

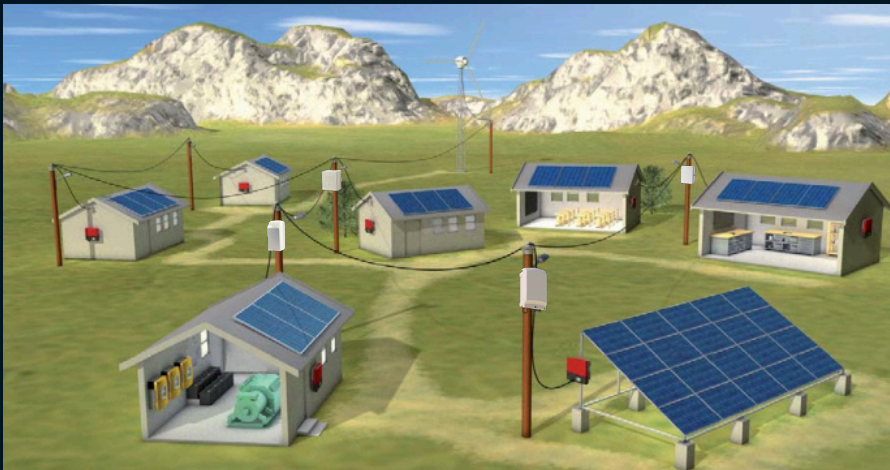

OFF GRID

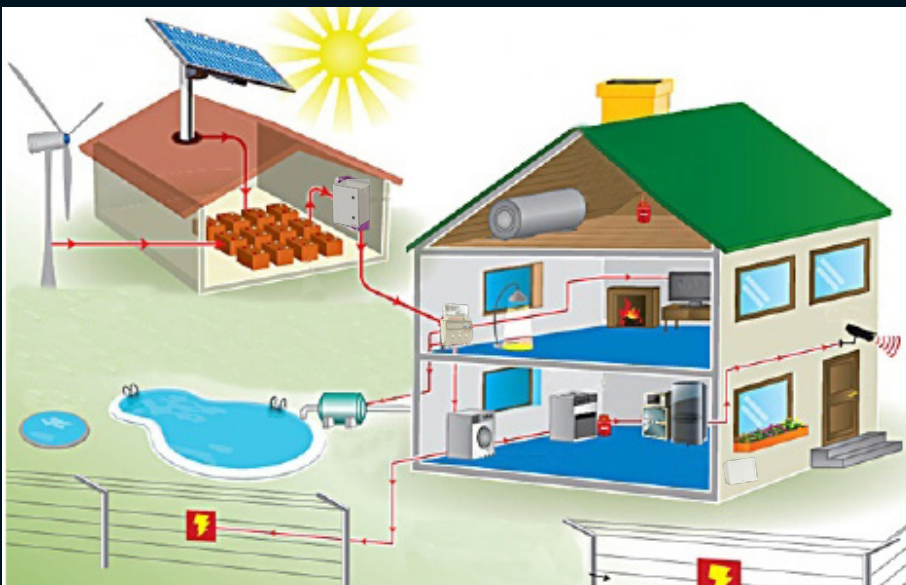

FOR DISTRIBUTION AND METERING

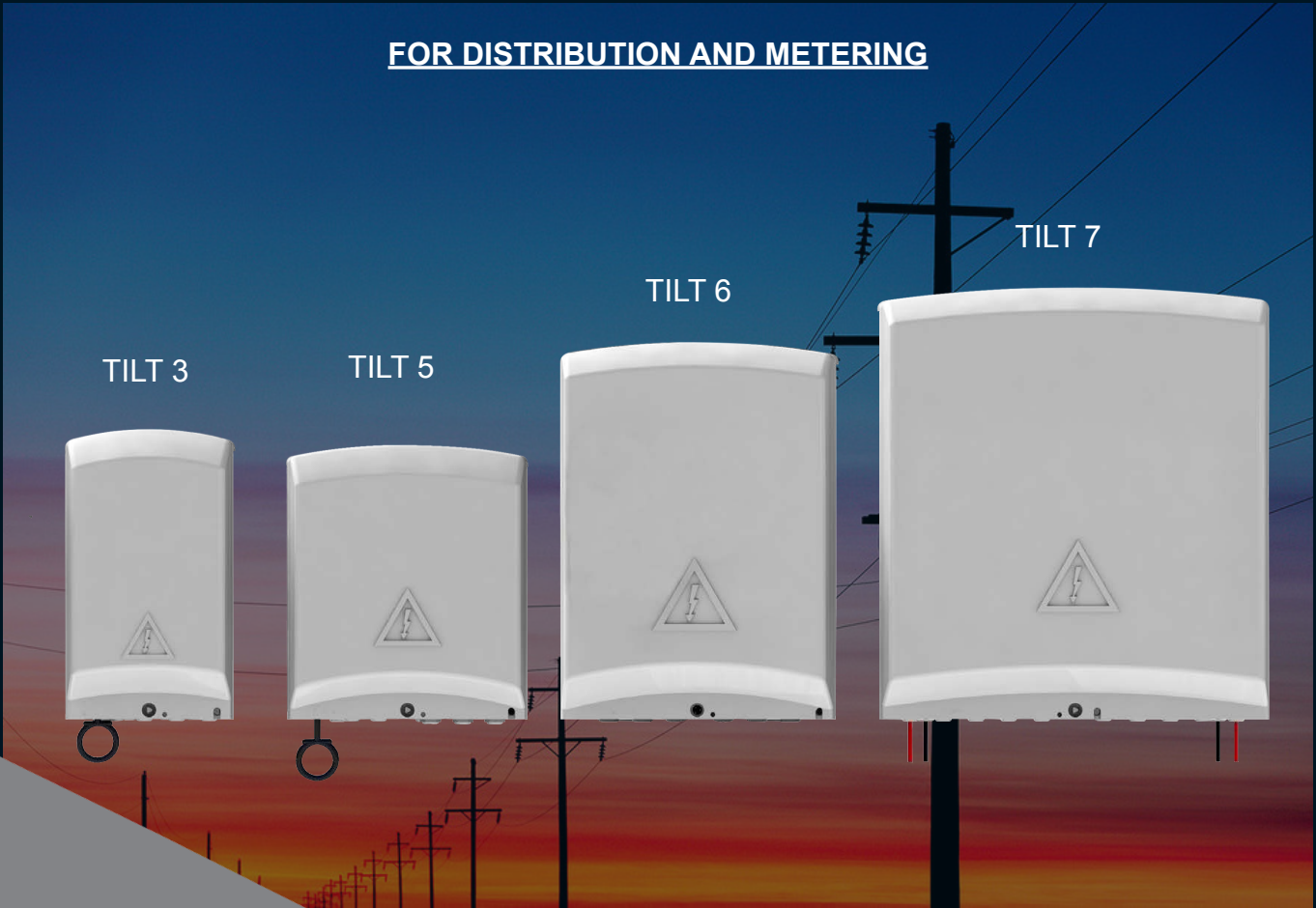

IN HOME DISTRIBUTION



Note: Backing Boards are a great way to pre-fit a solution for fast and reliable deployment.

Enclosures

Hinges

Locks

Handles

Accessories

Rotary Operating
Handles

Insulators

Transformer
Equipment

Index

Enclosures

Slide Lid Type (Empty)

Part Number and Description	Front Closed	Front Open	Back	H (mm)	W (mm)	D (mm)
Part Number: 040-645 CB44 - Single meter empty enclosure				235	105	120
Part Number: 040-794 CB45 - Single meter empty enclosure				325	169	133
Part Number: BUN5-1S5P BUN5 - 5 Way empty enclosure				309	209	121
Part Number: BUN-6WAY BUN6 - 6 Way Samite empty enclosure				309	209	121
Part Number: BUN-9WAY BUN9 - 9 Way Samite empty enclosure				340	260	150
Part Number: 040-643 CB9 - Empty enclosure				295	140	85
Part Number: 040-637 CB1 Slide Lid - Empty enclosure				255	185	120
Part Number: 040-636 CB2 - Empty enclosure				410	300	200

Hinges

Locks

Handles

Accessories

Rotary Operating Handles

Insulators

Transformer Equipment

Index

Notes:

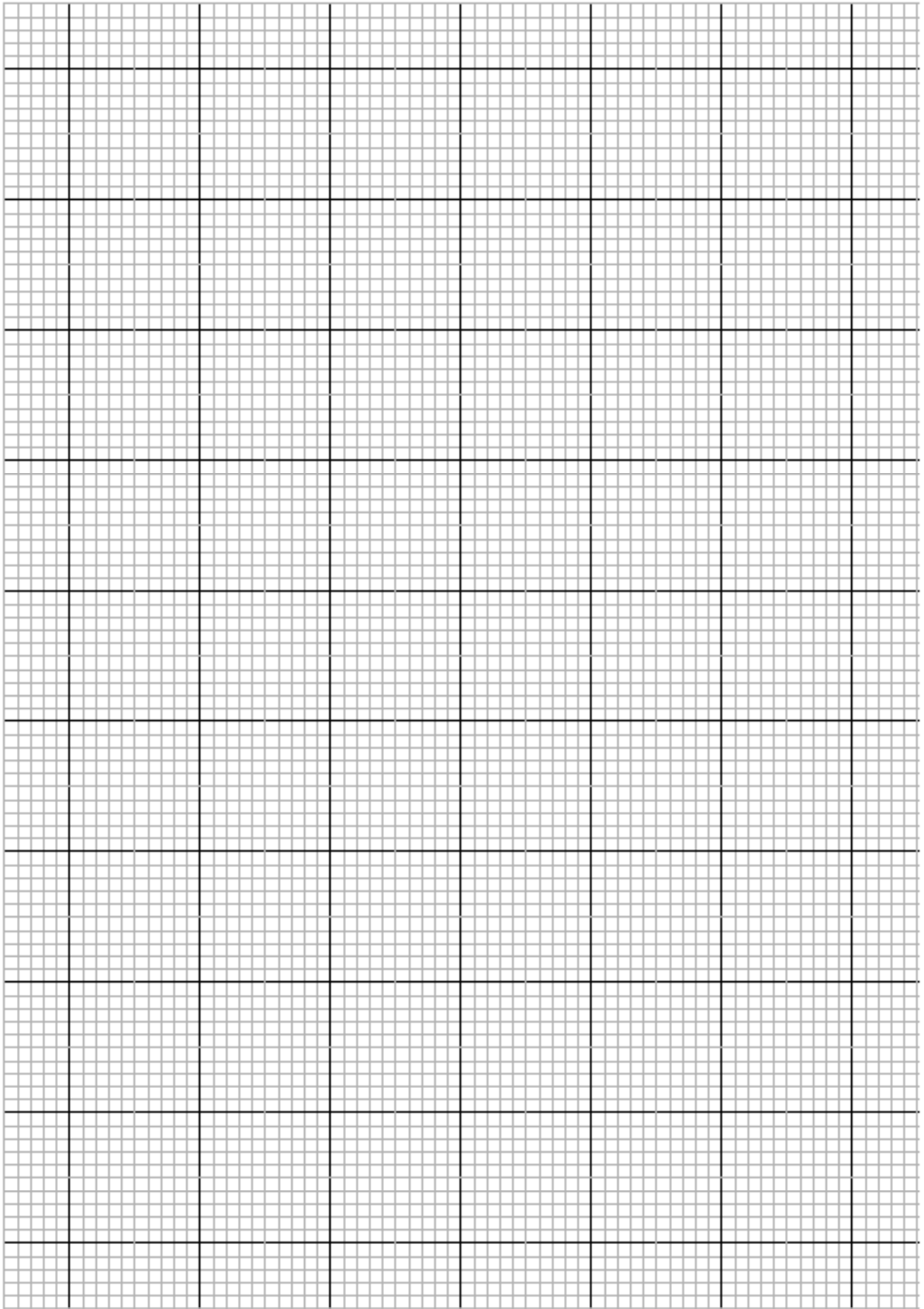



Weather & UV Resistant
(25 Year outdoor life)

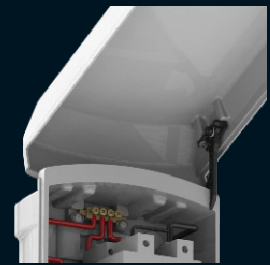

Built in door stay

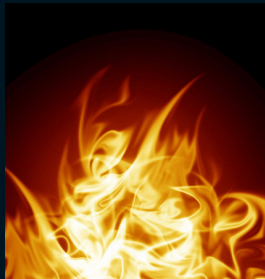

Flame Retardant



IP Level: 45

IK Level: 9



Wall and Pole mount
(No Bracket required)

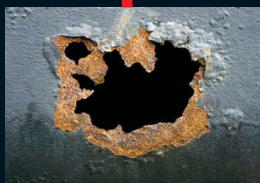

Durable GRP Material

Available in 4 sizes

Pad-lockable
* Fits padlock size 262 - 264. Sizes may vary according to make.





Part Number	Description	H (mm)	W (mm)	D (mm)
040-903	TILT 3	350	218	136
040-904	TILT 5	350	310	136
040-905	TILT 6	480	355	149
040-934	TILT 7	550	500	150

Wall Mounting or Pole Mounting - (No Additional Parts Required for Either Method)



Pole Mounting



Wall Mounting

- Enclosures
- Hinges
- Locks
- Handles
- Accessories
- Rotary Operating Handles
- Insulators
- Transformer Equipment
- Index

Enclosures
Hinges
Locks
Handles
Accessories
Rotary Operating Handles
Insulators
Transformer Equipment
Index

The value and complexity of equipment deployed across vast geographical areas has increased massively. The need to protect the function of these networks and devices has been met with all sorts of interesting ideas. Some challenges have been brilliantly overcome, but no solution has been able to completely address the convergence of the challenges that exist in this environment.

Often- overlooked or forgotten challenges

Vandalism: Due to the high value of enclosure content, bypassing a smart meter, disabling a surveillance system or simply stripping the contents for sale on the black market are growing global realities.

Access Control: Ease of access for authorised personnel is often adversely affected when trying to address vandalism challenge. Monitoring and tracking of authorised personnel is important as criminal elements sometimes gain authorised status.

IP Level (Water and Dust): While companies do their utmost to solve new challenges, the primary function of the enclosure is sometimes forgotten. Electrical systems fail because of three main factors, Temperature, water and dust. The latter two are addressed by the international standard IEC-529 (SANS-60529). Enclosures that are hand-made differ from each other and simply do not seal consistently.

UV resilience and weatherability: Accelerated UV testing is primarily a measure of colour degradation. However, real life exposure has to cope with temperature cycling, rain and particle rich wind. International standards do not currently exist to test this, leaving real life long-term field trials to provide the only genuine test of an enclosure's ability to withstand the elements.

Human contact risk/shock hazard: When the solution to vandalism involves metallic materials, there is a serious risk for personnel and public to come into contact with live electrical circuits. When such an enclosure is on a pole the risk for the person working at height is exaggerated.

Flammability: Some plastic materials are able to absorb impact very well. If one strikes a garden refuse bin with a hammer it just bounces off. The cautionary embossed words on the lid "No hot ash" point to a serious flaw in using such materials within an electrical network. All electrical enclosures are supposed to be non-flammable or at least self-extinguishing. Most utility companies require compliance to IEC 62208, which stipulates the parameters of glow wire testing and flammability. Using these materials specifically to address vandalism would incorrectly suppose that vandals only have access to hammers and not matches.

Weight: Whilst modern composites constantly deliver greater strength to weight performance, there is no way to get around the fact that weight is added when increasing the strength of a mechanical part. Keeping this weight down to a level that allows installation and does not compromise the pole or wall structure is a real challenge.

Signal interference: Some materials create a faraday cage effect and interfere with signals that often form part of the function of the installed equipment. Antennae that are mounted outside the enclosure are a vulnerable point that also attract unwanted attention.

Announcement

Solving the above challenges is complicated, and the resulting solution normally becomes costly bringing the price into question.

AllVault™ is the name given to the latest innovation. Experience learned while pioneering composite manhole chamber design allowed Allbro to create what we believe is the strongest composite enclosure ever to be sold commercially.

AllVault™ has been designed to address every one of the above challenges. The cost of lost revenue is not measured in the time and capital it takes to replace infrastructure. Systems that are bypassed or are out of order represent enormous values that can never be recovered. The financial case to be made to justify investment in this area is a very straightforward conclusion to prove.



Part Number	Description	H (mm)	W (mm)	D (mm)
040-906	AllVault empty with mechanical nut (IP 66)	581	403	201

AllVault™ is a world first. This high security outdoor box is made to offer exceptional protection from dust, water and unwanted personnel. The structure of the box is as important as the locking system and access control. Various locking systems have been catered for.

Mechanical

Simple and Effective Mechanical Locking Options

Coded Nuts (1000 variations) with magnetic caps works like coded wheel mag nuts

Key Based Access Control

Key based access control system

View our YouTube channel (Allbro Pty Ltd) Click on the video "Allbro bullet proof box" to view the AllVault™ being put to the test to showcase its true durability and strength.

- Enclosures
- Hinges
- Locks
- Handles
- Accessories
- Rotary Operating Handles
- Insulators
- Transformer Equipment
- Index